

1A Ultra-Low Vin Low Dropout Voltage Linear Regulator

DESCRIPTION

The BL8073G is a positive voltage output, high precision, low power consumption regulator. The output voltage is selectable in 100mV steps from 1.2V to 5.0V. It also can be customized on command.

The BL8073G has excellent load and line transient response and good temperature characteristics, which can assure the stability of chip and power system. And it uses trimming technique to guarantee output voltage accuracy within $\pm 2\%$.

The BL8073G is available in SOT23-5 package, which is lead(Pb)- free.

FEATURES

- Low quiescent current: 100uA (Typ.)
- Maximum output current: 1A
- Low dropout voltage:
350mV@ $I_{OUT}=1A$, $V_{OUT}=3.3V$ (Typ.)
- High PSRR: 65dB@1KHz (Typ.)
- Low temperature coefficient: $\pm 100\text{ppm}/^\circ\text{C}$
- Output voltage range: 1.2V~5.0V
- Highly accurate: $\pm 2\%$
- Thermal shutdown
- Overcurrent protection
- Low ESR ceramic capacitor compatible

APPLICATIONS

- Reference voltage source
- Battery powered equipment
- PC peripherals
- Wireless devices
- Instrumentation

TYPICAL APPLICATION

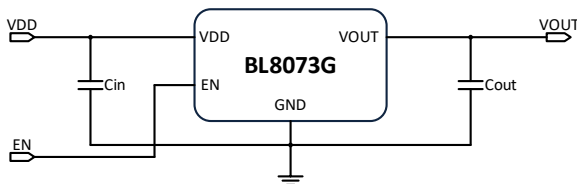

BLOCK DIAGRAM

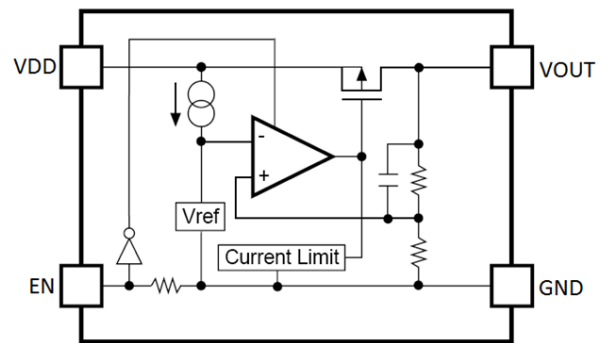

BL8073G

ORDERING INFORMATION

BL8073G [1](#) [2](#) [3](#) [4](#) [5](#)

Code	Description
1	Temperature&RoHS: C: -40~85°C, Pb Free RoHS Std.
2	Package type: B5: SOT23-5
3	Packing type: TR: Tape&Reel (Standard)
4	Output voltage: e.g., 12=1.2V 15=1.5V 18=1.8V 25=2.5V 33=3.3V 50=5.0V
5	Voltage accuracy: 1=±1% (Customized) Blank (default)=±2%

MARKING DESCRIPTON

Output Voltage Code X

VOUT	Code	VOUT	Code	VOUT	Code
1.2V	2	2.7V	<u>7</u>	3.9V	<u>9</u>
1.3V	3	2.8V	<u>8</u>	4.0V	<u>0</u>
1.4V	4	2.9V	<u>9</u>	4.1V	<u>1</u>
1.5V	5	3.0V	<u>0</u>	4.2V	<u>2</u>
1.8V	8	3.1V	<u>1</u>	4.3V	<u>3</u>
2.0V	<u>0</u>	3.2V	<u>2</u>	4.4V	<u>4</u>
2.1V	<u>1</u>	3.3V	<u>3</u>	4.5V	<u>5</u>
2.2V	<u>2</u>	3.4V	<u>4</u>	4.6V	<u>6</u>
2.3V	<u>3</u>	3.5V	<u>5</u>	4.7V	<u>7</u>
2.4V	<u>4</u>	3.6V	<u>6</u>	4.8V	<u>8</u>
2.5V	<u>5</u>	3.7V	<u>7</u>	4.9V	<u>9</u>
2.6V	<u>6</u>	3.8V	<u>8</u>	5.0V	<u>0</u>

PIN CONFIGURATION

Product classification		BL8073GCB5TR□□
JBXYW	JB: Product code	
	X: Output voltage	
	YW: Date code	
VDD	Supply voltage input	
GND	Ground	
EN	Chip enable	
NC	No connection	
VOUT	Output voltage	

Y: The Year of manufacturing, "1" stands for year 20X1, "2" stands for year 20X2, and "8" stands for year 20X8. (X=0,1,2,...,9)

W: The week of manufacturing. "A" stands for week 1,

"Z" stands for week 26, "A" stands for week 27, "Z" stands for week 52.

The date code of the 53rd week is the same as that of the first week of the next year. For example, the date code of the 53rd week of 2017 is the same as that of the first week of 2018, which are 1801 and 8A.

BL8073G

ABSOLUTE MAXIMUM RATING

Parameter	Value
Max input voltage	8V
Max operating junction temperature (T _J)	125°C
Power dissipation	600mW
Package thermal resistance (θ _{JC})	100°C/W
Storage temperature (T _S)	-65°C to 150°C
Lead temperature & time	260°C, 10s

RECOMMENDED WORK CONDITIONS

Parameter	Value
Input voltage range	Max. 6V
Ambient temperature (T _A)	-40°C to 85°C

ELECTRICAL CHARACTERISTICS

Test condition: C_{IN}=4.7uF, C_{OUT}=4.7uF, T_A=25°C, unless otherwise specified.

Symbol	Parameter	Conditions	Min	Typ	Max	Units
V _{DD}	Input voltage		1.5*		6	V
V _{OUT}	Output voltage	V _{DD} =Set V _{OUT} +1V 1mA≤I _{OUT} ≤10mA	V _{OUT} X0.98	V _{OUT}	V _{OUT} X1.02	V
			V _{OUT} -0.03		V _{OUT} +0.03	
I _{OUT} (Max.) **	Maximum output current	V _{DD} -V _{OUT} =1V	1			A
V _{DROP}	Dropout voltage	V _{OUT} =3.3V, I _{OUT} =1A		300	500	mV
$\frac{\Delta V_{out}}{\Delta V_{dd} \cdot V_{out}}$	Line regulation	I _{OUT} =10mA, Set V _{OUT} +1V≤V _{DD} ≤6V		0.05	0.2	%/V
ΔV _{out}	Load regulation	V _{DD} =Set V _{OUT} +1V 1mA≤I _{OUT} ≤1A		30	60	mV
I _Q	Supply current	V _{DD} =Set V _{OUT} +1V, V _{OUT} floating		100	150	uA
I _{STANDBY}	Supply current (Standby)	V _{DD} =Set V _{OUT} +1V, V _{EN} =GND		0.1	1.0	uA
$\frac{\Delta V_{out}}{\Delta T \cdot V_{out}}$	Output voltage temperature coefficient	I _{OUT} =10mA		±100		ppm/°C
PSRR	Ripple rejection	f=1KHz, ripple=0.5Vp-p, V _{DD} =Set V _{OUT} +1V		65		dB
R _{PD}	EN pull down resistance			5		MΩ
V _{EN_H}	EN input voltage "H"		0.95		V _{DD}	V
V _{EN_L}	EN input voltage "L"		0		0.25	V
T _{SD}	Thermal shutdown temp	V _{DD} =Set V _{OUT} +1V, I _{OUT} =10mA		150		°C
T _{SH}	Thermal shutdown hysteresis	V _{DD} =Set V _{OUT} +1V, I _{OUT} =10mA		30		°C

Note: *I_{OUT}=350mA@V_{DD}=1.5V, V_{OUT}=1.2V

**The maximum power rating of each package is a constant, so along with the change of I_{LOAD}, the V_{DD}-V_{OUT} should be controlled to a certain range to ensure the normal operation.

TYPICAL PERFORMANCE CHARACTERISTICS

Load Regulation
(Vout=3.3V)

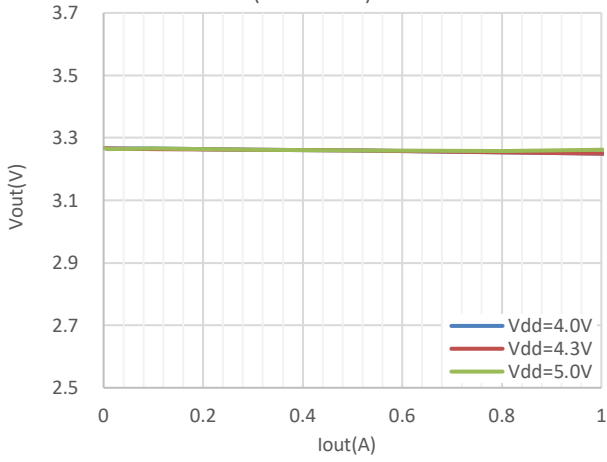

Line Regulation
(Vout=3.3V)

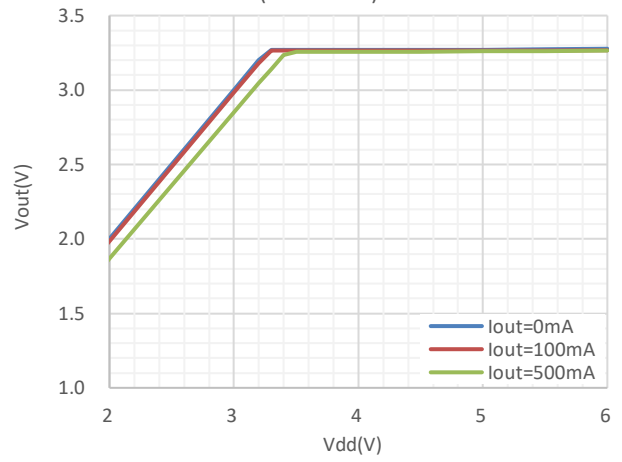

Dropout Voltage
(Vout=3.3V)

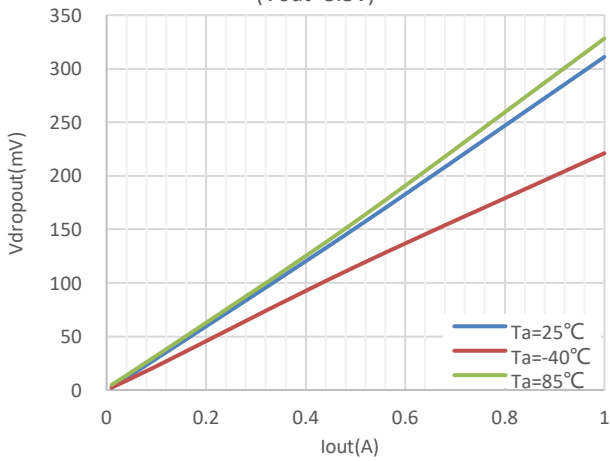

I_Q
(Vout=3.3V)

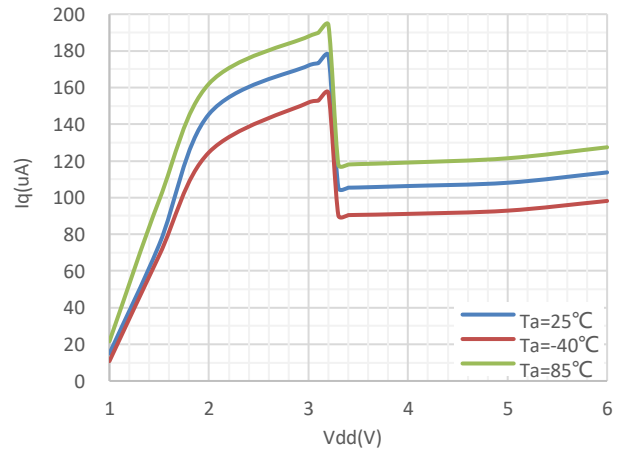

PSRR

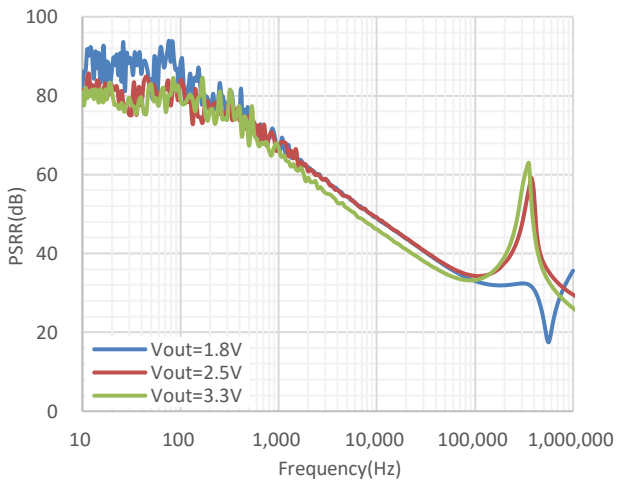

Vout vs. Temp
(Vdd=5V, Iout=10mA)

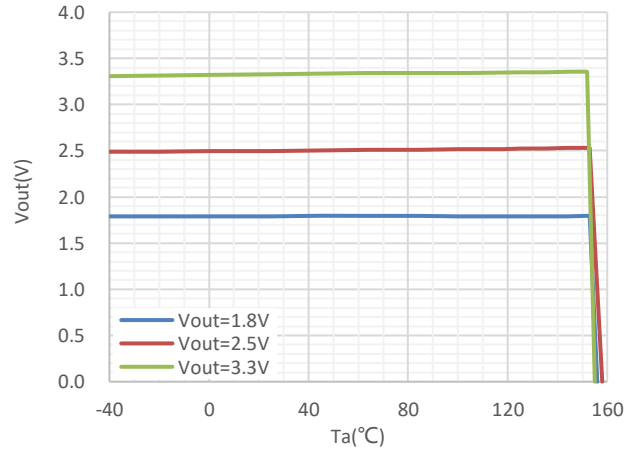

Load Transient Response

Vdd=5V, Vout=3.3V, Iout=10mA-1A

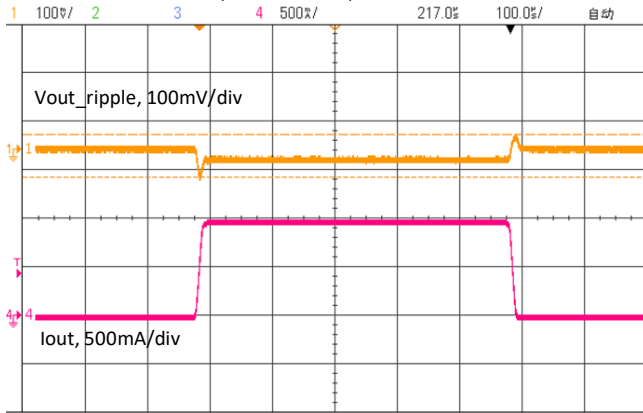

CH1: Vout_ripple, CH4: Iout

Line Transient Response

Vdd=4.3V-5.3V, Vout=3.3V, Iout=10mA

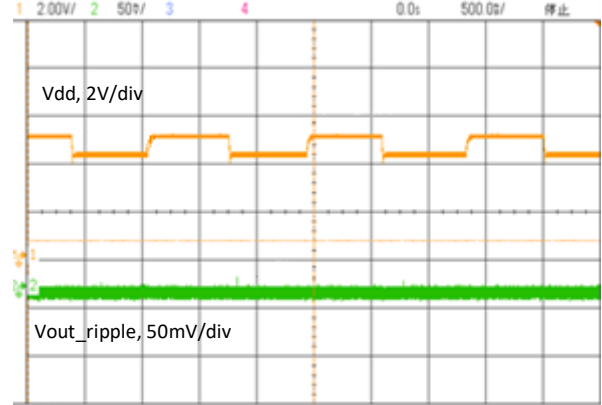

CH1: Vdd, CH2: Vout_ripple

EN Power On

Vdd=5V, Vout=1.8V, Iout=10mA, EN=0V to 3V

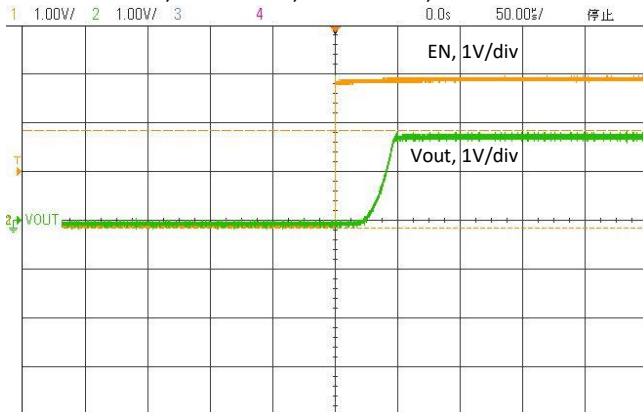

CH1: EN, CH2: Vout

EN Power Off

Vdd=5V, Vout=1.8V, Iout=10mA, EN=3V to 0V

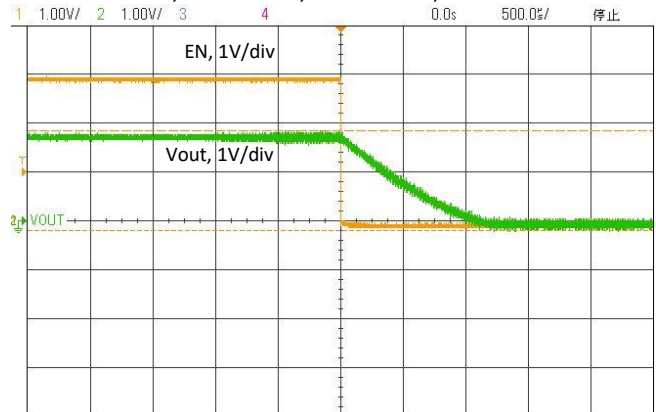

CH1: EN, CH2: Vout

Safe Operation Area

(Vout=3.3V)

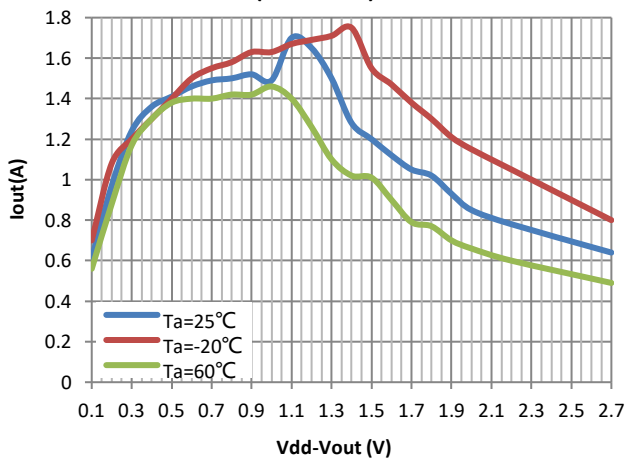

BL8073G

PACKAGE OUTLINE

Package	SOT23-5	Devices per reel	3000pcs
Package dimension:			
<p>The technical drawing illustrates the BL8073G SOT23-5 package. It includes three views: a top view, a side view, and a perspective view. The top view shows a rectangular body with five pins. The overall width is 2.9 ± 0.2 mm, and the overall height is 2.8 ± 0.3 mm. The distance between the two top pins is 1.9 ± 0.2 mm, with each pin offset by 0.95 mm from the center. The distance between the two bottom pins is 0.4 ± 0.1 mm. The side view shows a maximum height of $1.1^{+0.2}_{-0.1}$ mm, a width of 0.8 ± 0.1 mm, and a lead thickness of $0.15^{+0.1}_{-0.05}$ mm. A lead length of 0.2 mm is indicated as a minimum. The bottom view shows the package from a different angle, highlighting the pin arrangement.</p>			
Unit: mm			