

1. Description

BLG3040 is obtained by advanced ignition IGBTs technology which reduce the conduction loss, enhance the SCIS capability. Internally integrated diodes can provide the voltage clamping without the need for external components. The IGBT is suitable device for automotive ignition circuits, specifically as a coil driver.

KEY CHARACTERISTICS

Parameter	Value	Unit
V_{CES}	400	V
$V_{CE(sat).Typ}$	1.25	V
$E_{SCIS}@T_J=25\text{ }^\circ\text{C}$	300	mJ
ESD	4	kV

FEATURES

- Low V_{CEsat}
- High SCIS Energy
- Logic Level Gate Drive

APPLICATIONS

- Automotive ignition Coil Driver Circuits
- Coil-On Plug Application

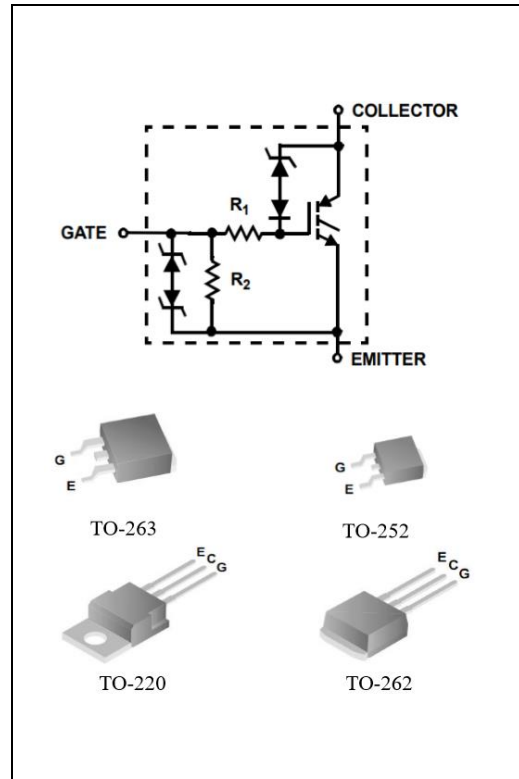

ORDERING INFORMATION

Ordering Codes	Package	Product Code	Packing
BLG3040-D	TO-252	G3040	Tape Reel
BLG3040-P	TO-220		Tube
BLG3040-I	TO-262		Tube
BLG3040-B	TO-263		Tape Reel

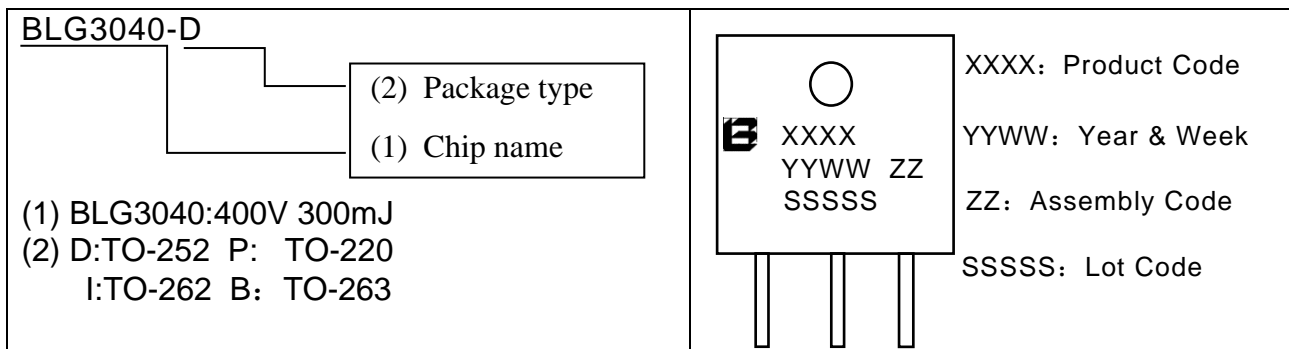

2. ABSOLUTE RATINGS

at $T_C = 25^\circ\text{C}$, unless otherwise specified

Symbol	Parameter	Rating	Units
V_{CES}	Collector-Emitter Voltage ($I_C=1\text{mA}$)	430	V
V_{ECS}	Emitter to Collector Voltage ($I_C=10\text{mA}$)	24	V
E_{SCIS}	SCIS Energy@ $T_J=25^\circ\text{C}$, $I_{SCIS}=14.2\text{A}$	300	mJ
	SCIS Energy@ $T_J=150^\circ\text{C}$, $I_{SCIS}=10.6\text{A}$	170	mJ
I_C	Collector Current @ $T_C=25^\circ\text{C}$	21	A
	Collector Current @ $T_C=100^\circ\text{C}$	17	A
ESD	Electrostatic Discharge Voltage (HBM) at 100pF,1500Ω	4	kV
V_{GEM}	Gate- Emitter Voltage Continuous	±10	V
P_D	Power Dissipation @ $T_C = 25^\circ\text{C}$	150	W
T_J, T_{stg}	Operating Junction and Storage Temperature Range	-40 to 175	°C
T_L	Maximum Temperature for Soldering	260	°C

3. Thermal characteristics

Symbol	Parameter	Package	RATINGS	Units
$R_{\theta JC}$	Junction-to-Case	TO-252/TO-220/TO-262/TO-263	1.0	°C /W

4. Electrical Characteristics

at $T_C = 25^\circ\text{C}$, unless otherwise specified

OFF Characteristics						
Symbol	Parameter	Test Conditions	Values			Units
			Min.	Typ.	Max.	
BV_{CER}	Collector to Emitter Breakdown Voltage	$V_{GE}=0\text{V}$, $I_C=2\text{mA}$, $R_G=1\text{k}\Omega$	370	400	430	V
BV_{CES}	Collector to Emitter Breakdown Voltage	$V_{GE}=0\text{V}$, $I_C=10\text{mA}$, $R_G=0\Omega$	390	420	450	V
BV_{ECS}	Emitter to Collector Breakdown Voltage	$V_{GE}=0\text{V}$, $I_C=-75\text{mA}$	30	--	--	V
BV_{GES}	Gate to Emitter Breakdown Voltage	$I_{GES}=\pm 2\text{mA}$	±12	±14		V
I_{CER}	Collector to Emitter Leakage Current	$V_{CE}=250\text{V}$, $R_G=1\text{k}\Omega$, $T_J=25^\circ\text{C}$	--	--	25	μA
		$V_{CE}=250\text{V}$, $R_G=1\text{k}\Omega$, $T_J=150^\circ\text{C}$	--	--	1	mA

I_{ECS}	Emitter to Collector Leakage Current	$V_{EC}=24V, T_J=25^{\circ}C$	--	--	1	mA
		$V_{EC}=24V, T_J=150^{\circ}C$			40	mA
R_1	Series Gate Resistance		--	70		Ω
R_2	Gate to Emitter Resistance		10		26	k Ω

ON Characteristics

Symbol	Parameter	Test Conditions	Values			Units
			Min.	Typ.	Max.	
$V_{CE(sat)}$	Collector-Emitter Saturation Voltage	$V_{GE}=4V, I_C=6A, T_J=25^{\circ}C$	--	1.20	1.60	V
$V_{CE(sat)}$	Collector-Emitter Saturation Voltage	$V_{GE}=4.5V, I_C=10A, T_J=175^{\circ}C$	--	1.52	1.80	V
$V_{CE(sat)}$	Collector-Emitter Saturation Voltage	$V_{GE}=4.5V, I_C=15A, T_J=175^{\circ}C$	--	1.90	2.20	V
$V_{GE(TH)}$	Gate Threshold Voltage	$V_{CE} = V_{GE}, I_C = 1mA$	1.30	--	2.20	V

Pulse width $t_p \leq 300\mu s, \delta \leq 2\%$

Dynamic Characteristics

Symbol	Parameter	Test Conditions	Values			Units
			Min.	Typ.	Max.	
C_{iss}	Input Capacitance	$V_{GE} = 0V$ $V_{CE} = 25V$ $f=1.0MHz$	--	1250	--	pF
C_{oss}	Output Capacitance		--	69	--	
C_{rss}	Reverse Transfer Capacitance		--	15	--	
Q_g	Total Gate Charge	$I_C=10A, V_{CE}=12V, V_{GE}=5V$	--	7.2	--	nC

Switching Characteristics

Symbol	Parameter	Test Conditions	Values			Units
			Min.	Typ.	Max.	
$t_{d(ON)}$	Turn-on Delay Time	$V_{CE} = 14V, R_L=1\Omega,$ $V_{GE} = 5V, R_G = 1k\Omega,$ $T_J=25^{\circ}C$	--	0.85	4	μs
t_r	Rise Time		--	2.50	7	
$t_{d(OFF)}$	Turn-Off Delay Time	$V_{CE} = 300V, L=500\mu H,$ $V_{GE} = 5V, R_G = 1k\Omega,$ $T_J=25^{\circ}C$	--	4.40	15	
t_f	Fall Time		--	1.90	15	

5. Characteristics Curves

Figure 1 Collector-Emitter Saturation Voltage vs Junction Temperature

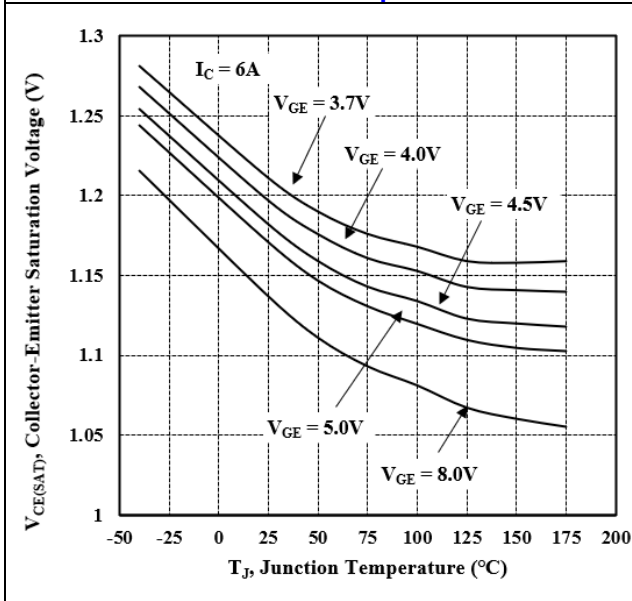

Figure 2 Collector-Emitter Saturation Voltage vs Junction Temperature

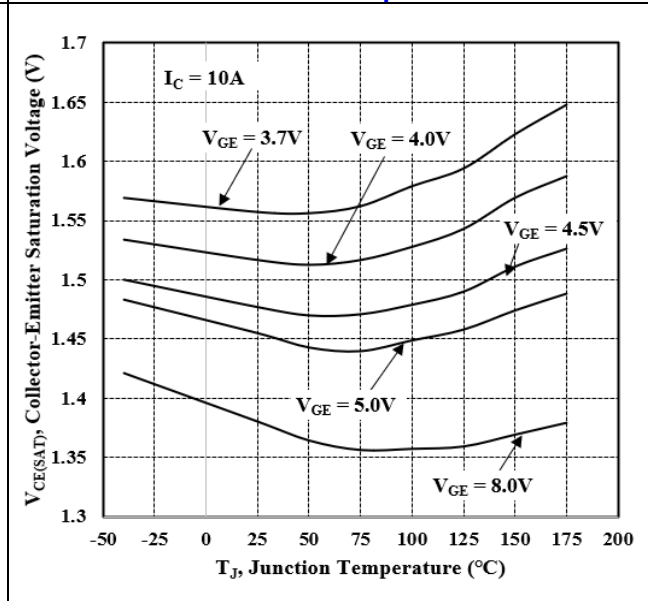

Figure 3 Self Clamped Inductive Switching Current vs Inductance

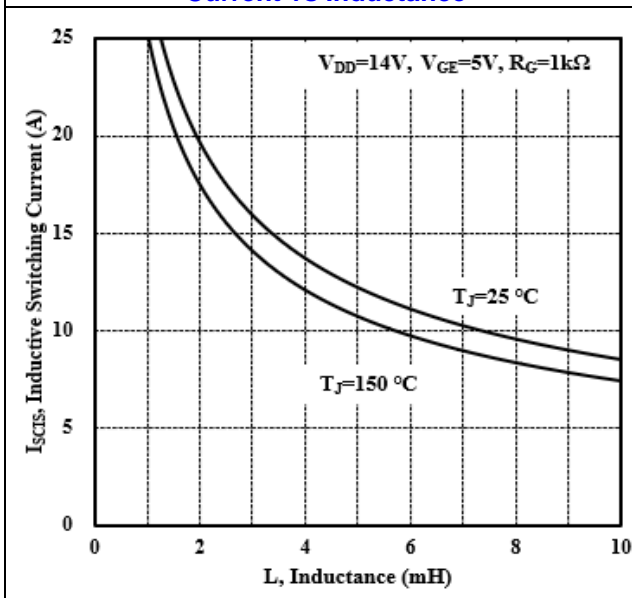

Figure 4 Self Clamped Inductive Switching Current vs Inductance

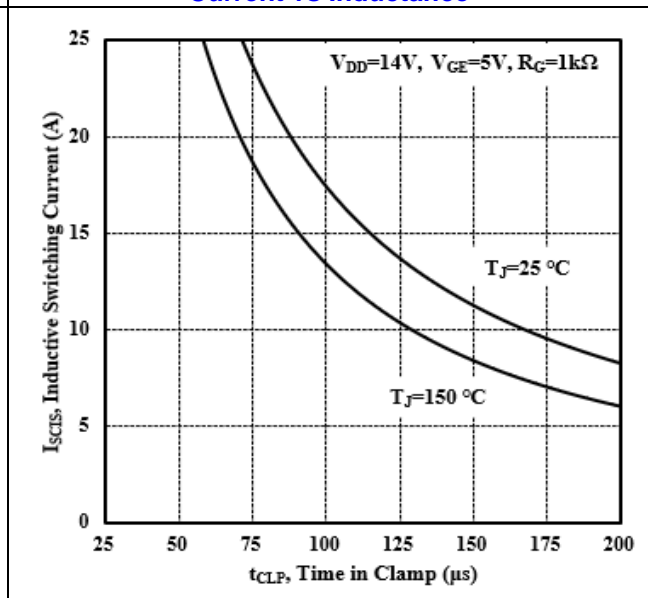

Figure 5 Power Dissipation vs Case Temperature

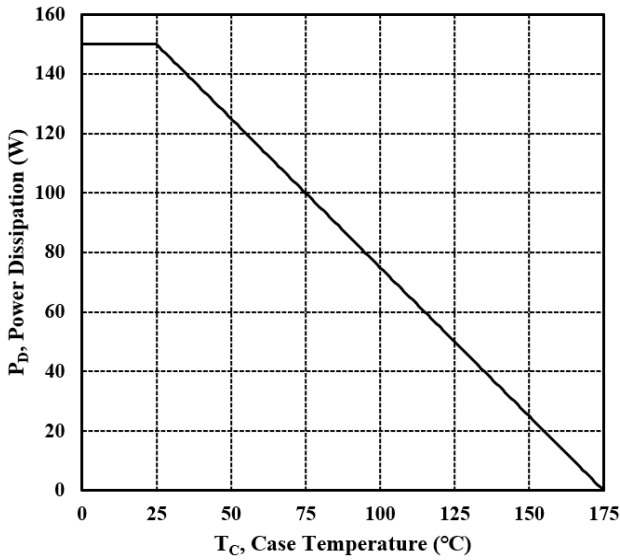

Figure 6. DC Collector Current vs Case Temperature

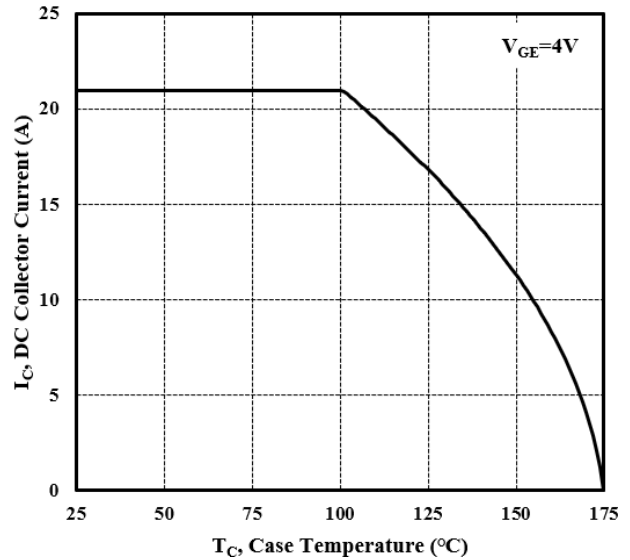

Figure 7 Threshold Voltage vs Junction Temperature

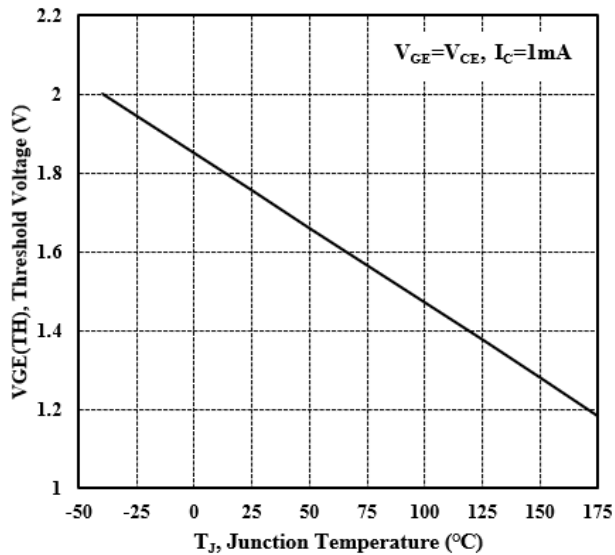

Figure 8 Breakdown Voltage vs Series Gate Resistance

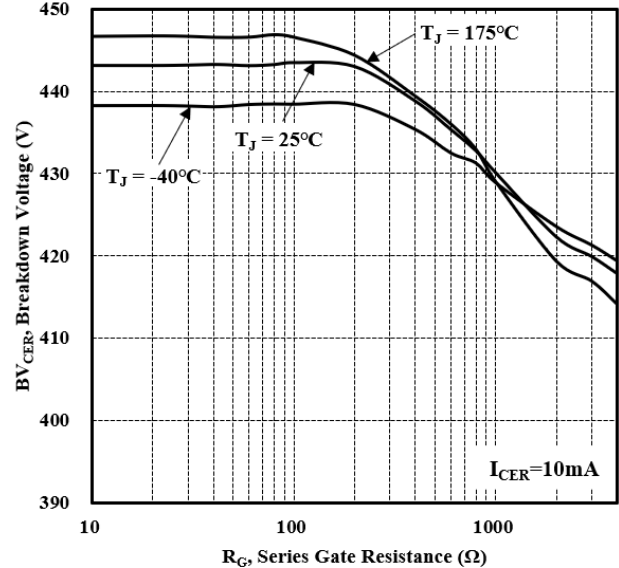

Figure 9 Leakage Current vs Junction Temperature

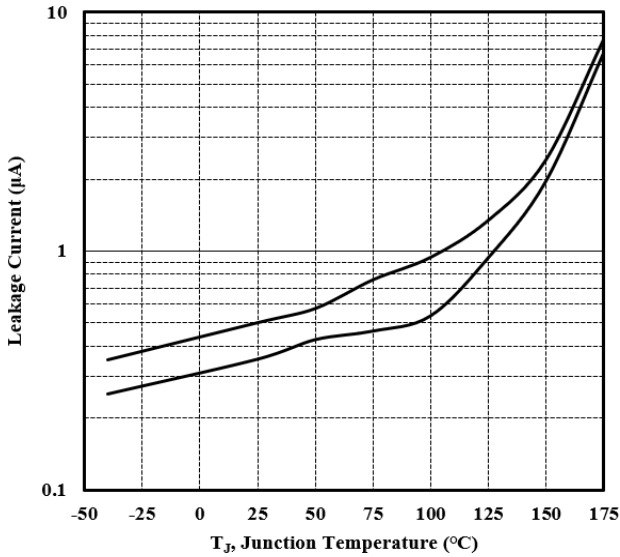

Figure 10 Collector-Emitter Voltage vs Collector Current

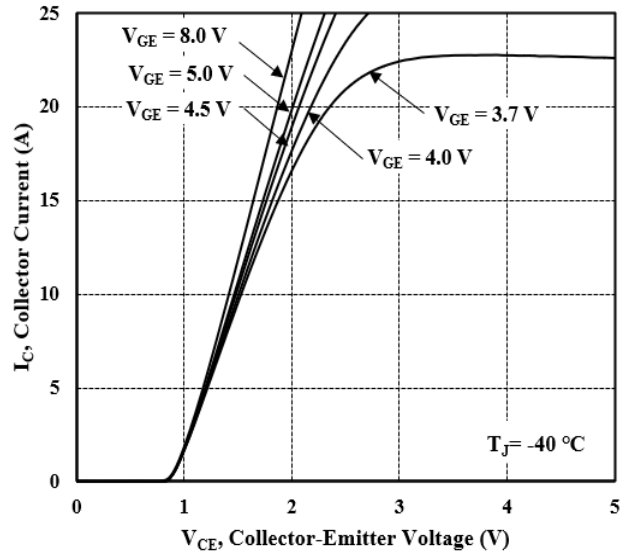

Figure 11 Collector-Emitter Voltage vs Collector Current

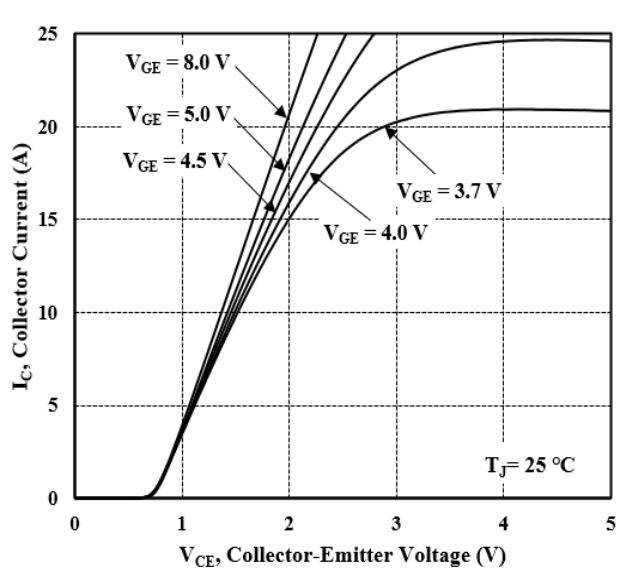

Figure 12 Collector-Emitter Voltage vs Collector Current

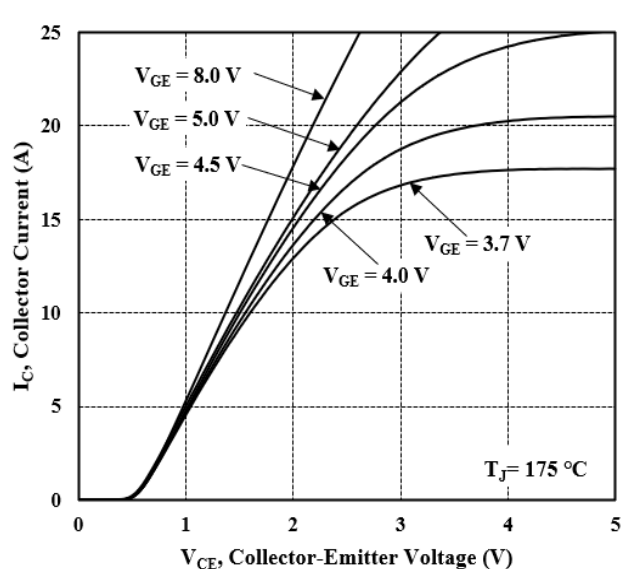

Figure 13 Transfer Characteristics

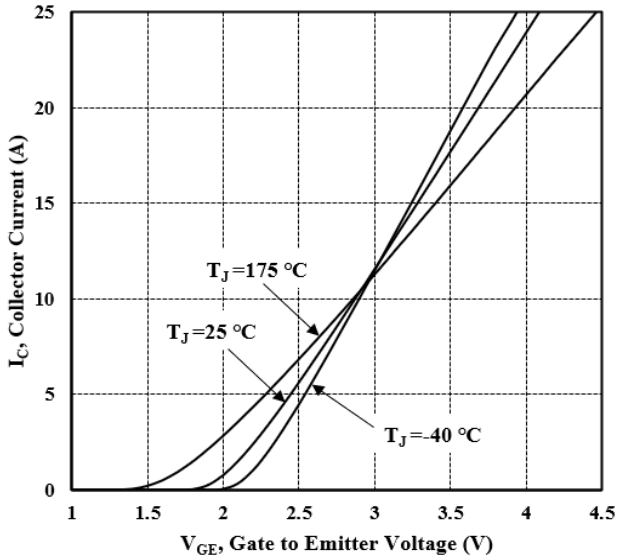

Figure 14 Capacitance vs Collector to Emitter Voltage

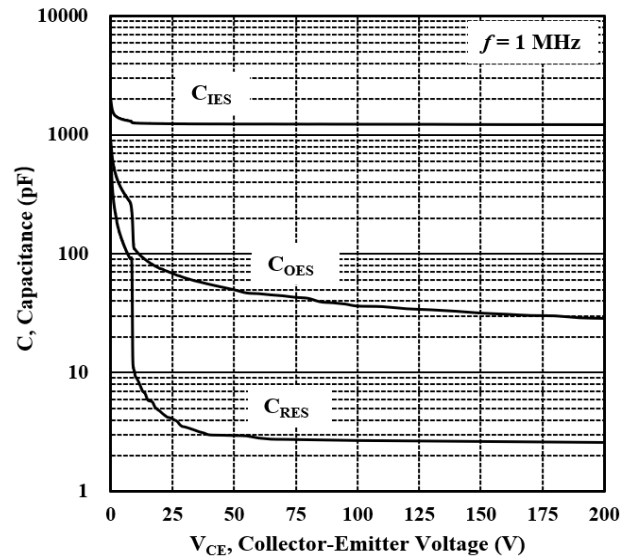

Figure 15 Gate Charge vs Gate to Emitter Voltage

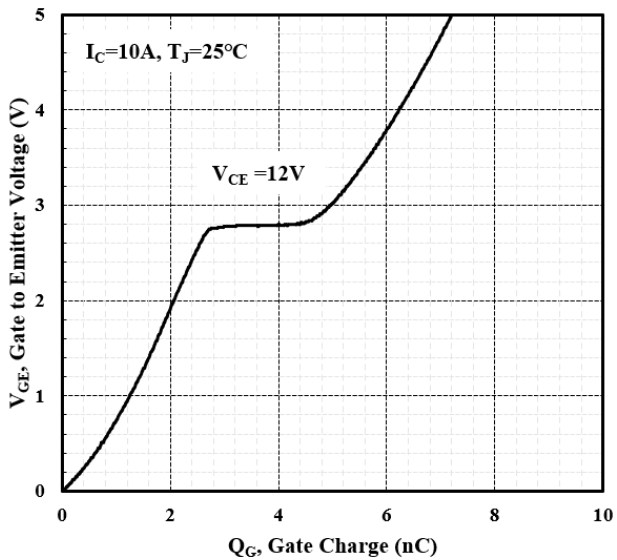

Figure 16 Switching Time vs Junction Temperature

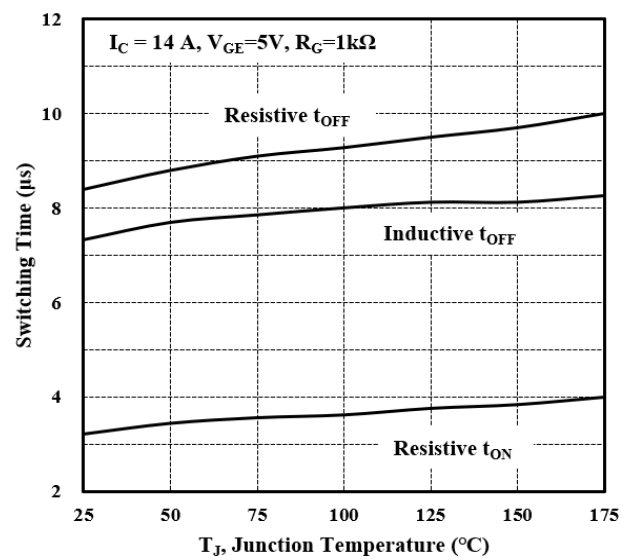
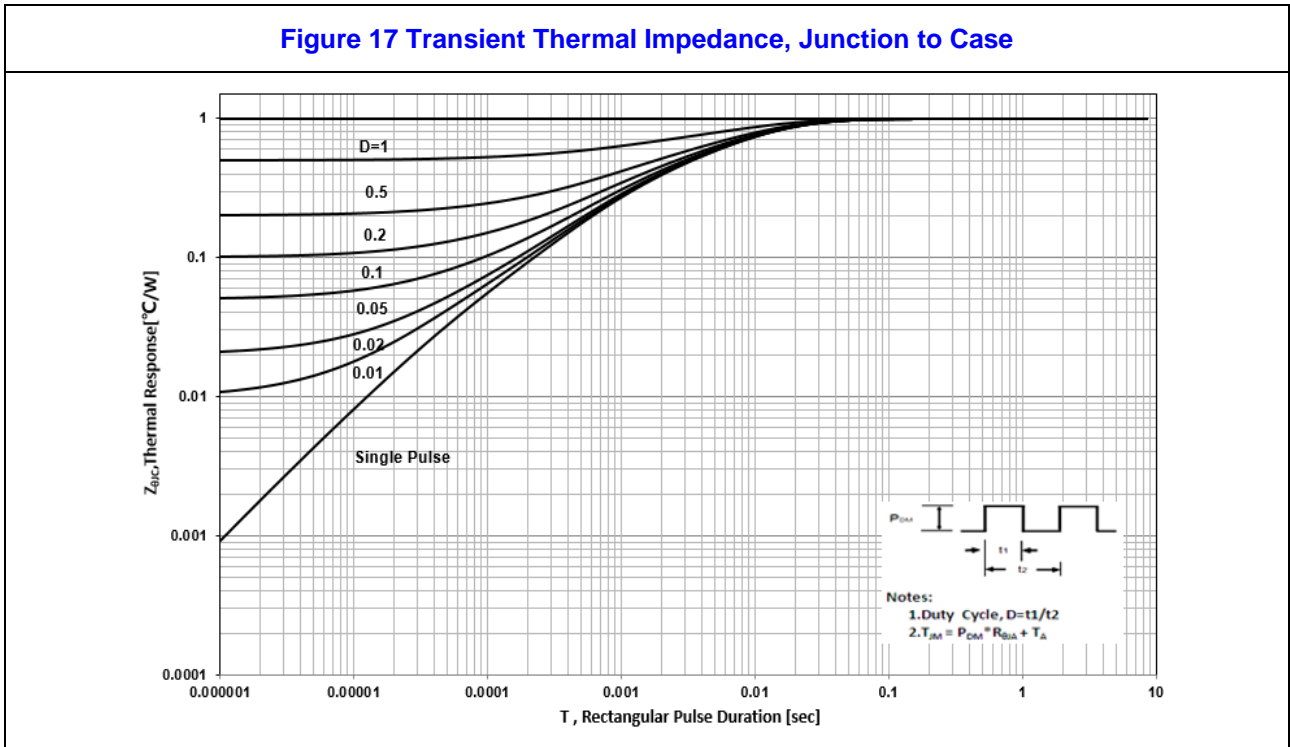
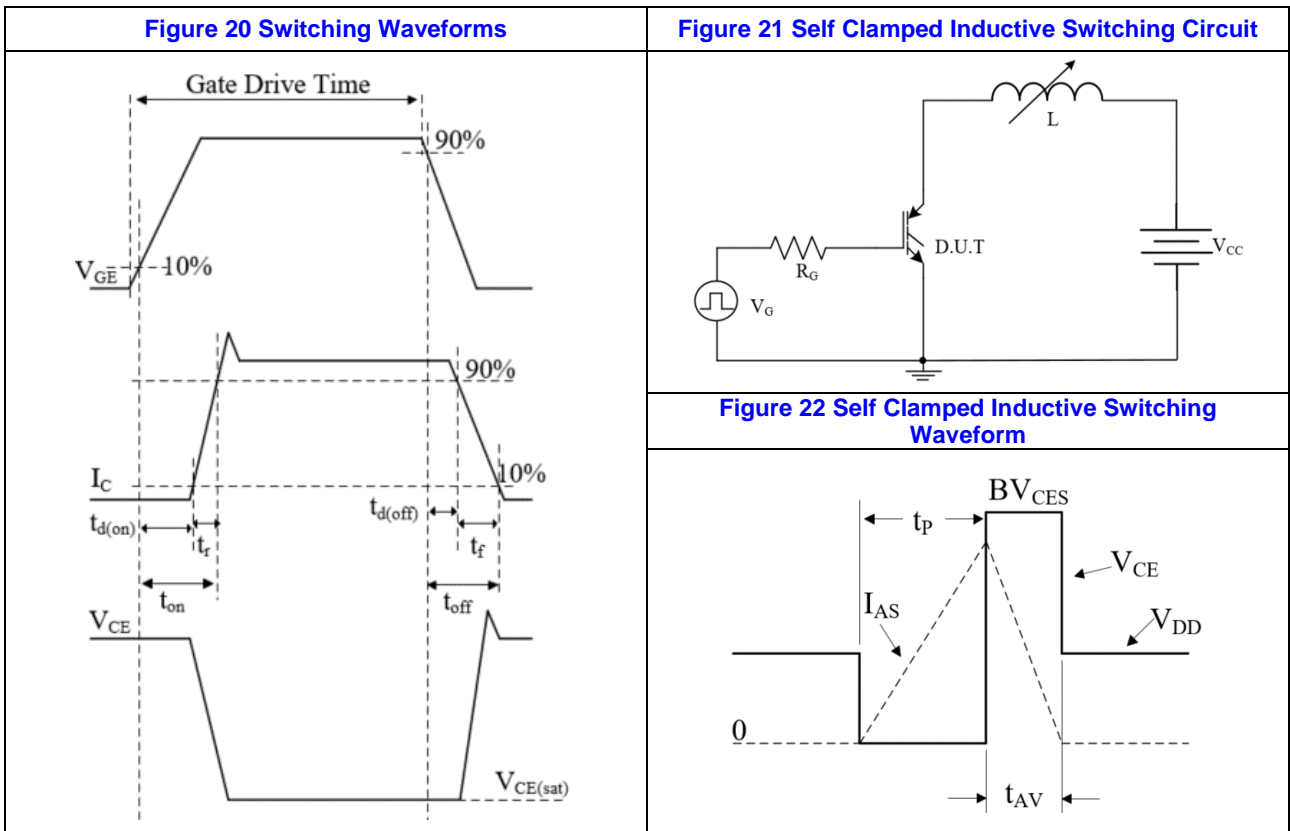
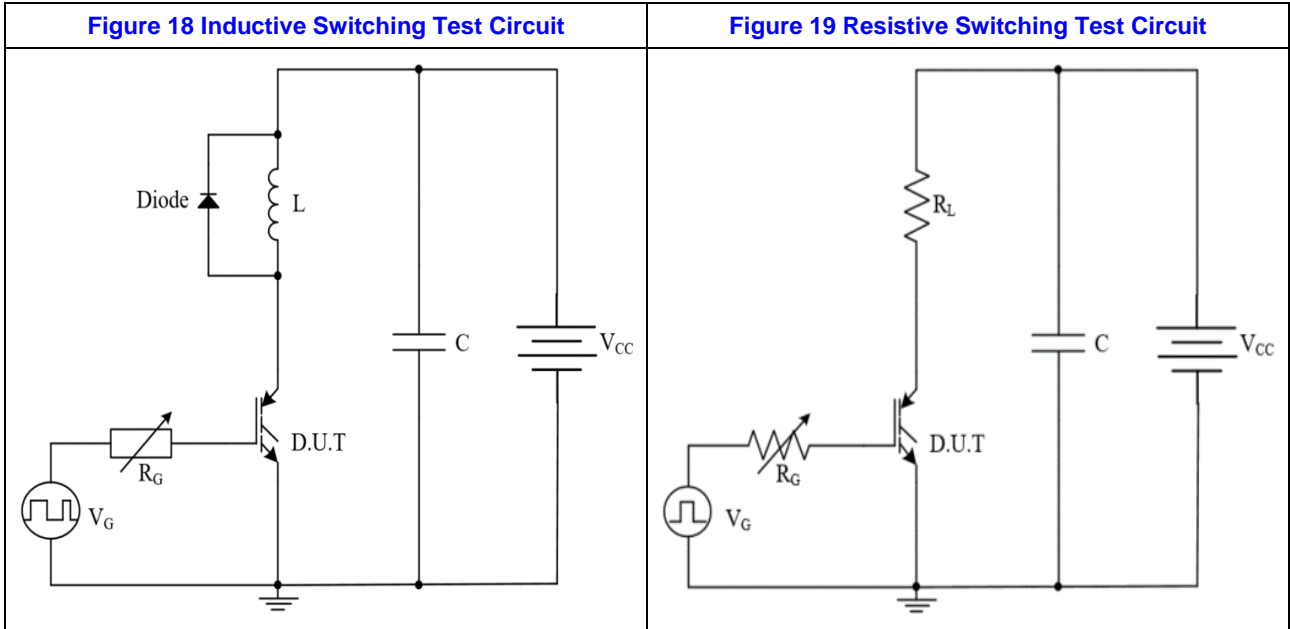

Figure 17 Transient Thermal Impedance, Junction to Case



6. Test Circuit and Waveform



7. Package Description

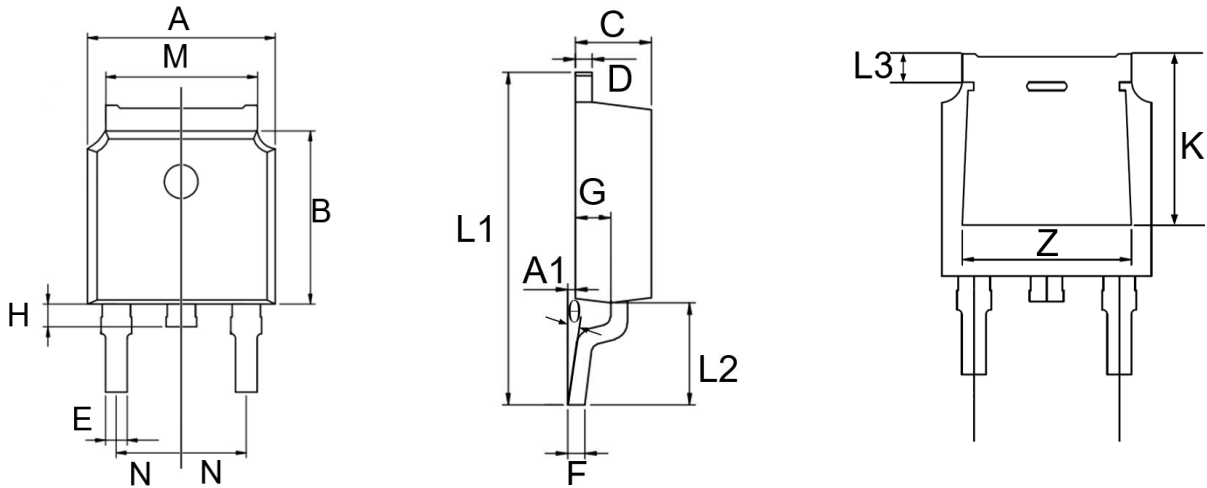

TO-252 Package

Items	Values(mm)		
	MIN	NOM	MAX
A	6.45	6.60	6.75
A1	0.05	0.10	0.20
B	5.95	6.10	6.25
C	2.15	2.30	2.45
D	0.40	0.50	0.60
E	0.66	0.76	0.86
F	0.40	0.500	0.6
G	0.91	1.07	1.22
H	0.60	0.80	1.00
K	3.80		
L1	9.80	10.10	10.40
L2	2.80	3.10	3.40
L3	0.70	0.80	1.00
H	0.60	0.80	1.00
M	5.12	5.32	5.52
2N	4.57		
Z	4.80		
θ	0°	-	8°

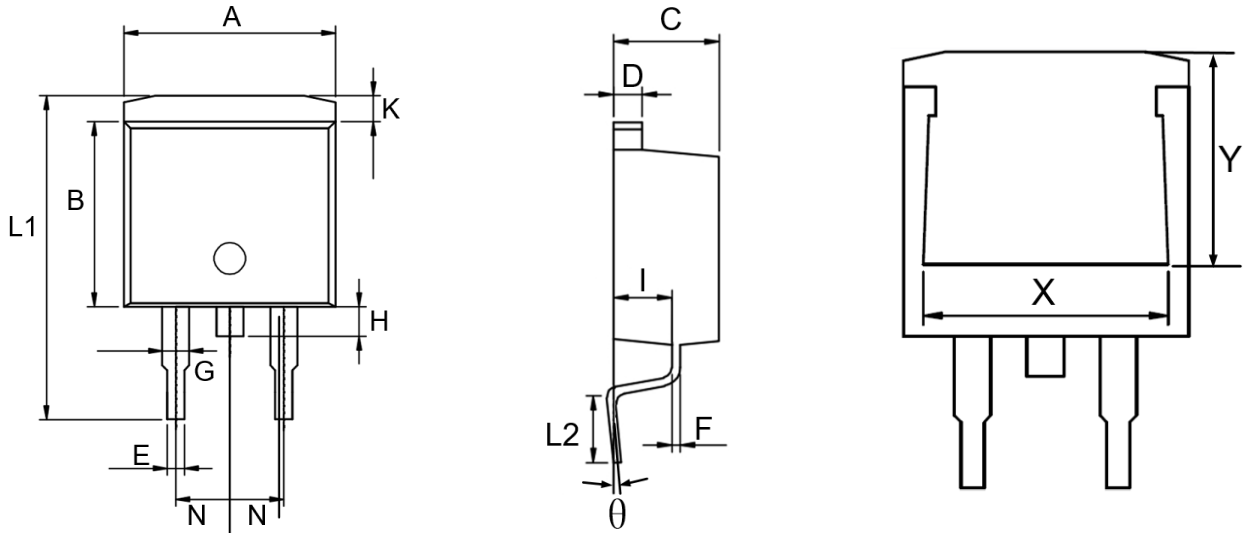

TO-263 Package

Items	Values (mm)		
	MIN	NOM	MAX
A	9.85	10.15	10.45
B	8.46	8.66	8.86
C	4.50	4.70	4.90
D	1.17	1.27	1.37
E	0.72	0.82	0.92
F	0.28	0.38	0.48
G	1.12	1.27	1.42
H	1.20	1.40	1.60
I	2.45	2.60	2.70
K	1.01	1.23	1.50
L1	14.75	15.15	15.55
L2	2.30	2.55	2.80
2N	5.08		
X	7.90	8.10	8.40
Y	5.50	5.70	5.90
θ	0°	7°	8°

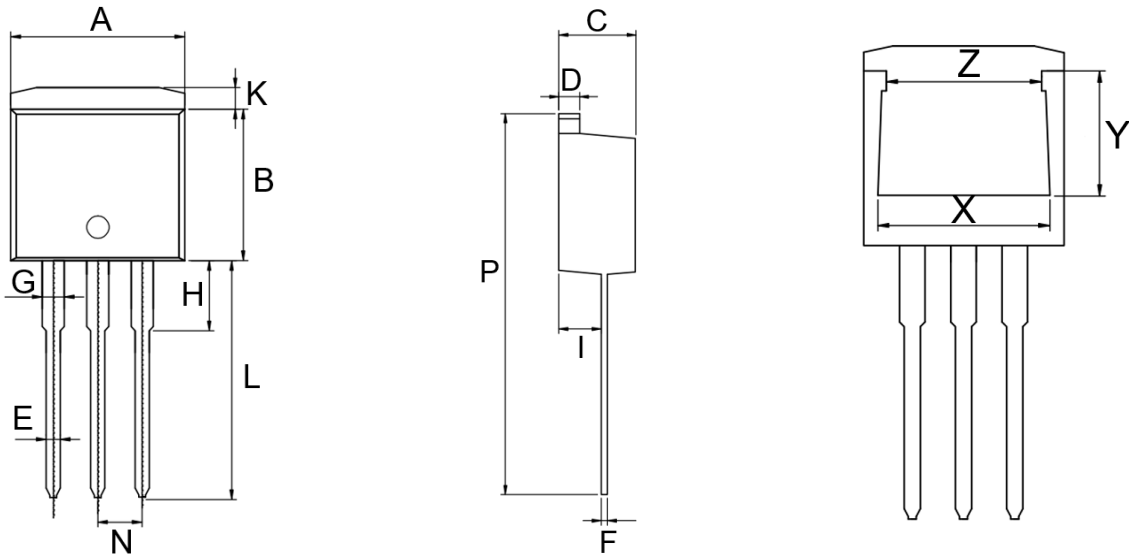

TO-262 Package

Items	Values (mm)		
	MIN	NOM	MAX
A	9.85	10.15	10.45
B	8.46	8.66	8.86
C	4.50	4.70	4.90
D	1.17	1.27	1.37
E	0.72	0.82	0.92
F	0.28	0.38	0.48
G	1.12	1.27	1.42
H	3.85	4.05	4.35
I	2.45	2.60	2.70
K	1.01	1.23	1.50
L	13.10	13.60	14.10
N	-	2.54	-
P	23.20	23.60	24.00
X	7.90	8.10	8.40
Y	5.50	5.70	5.90
Z	7.10	7.30	7.50

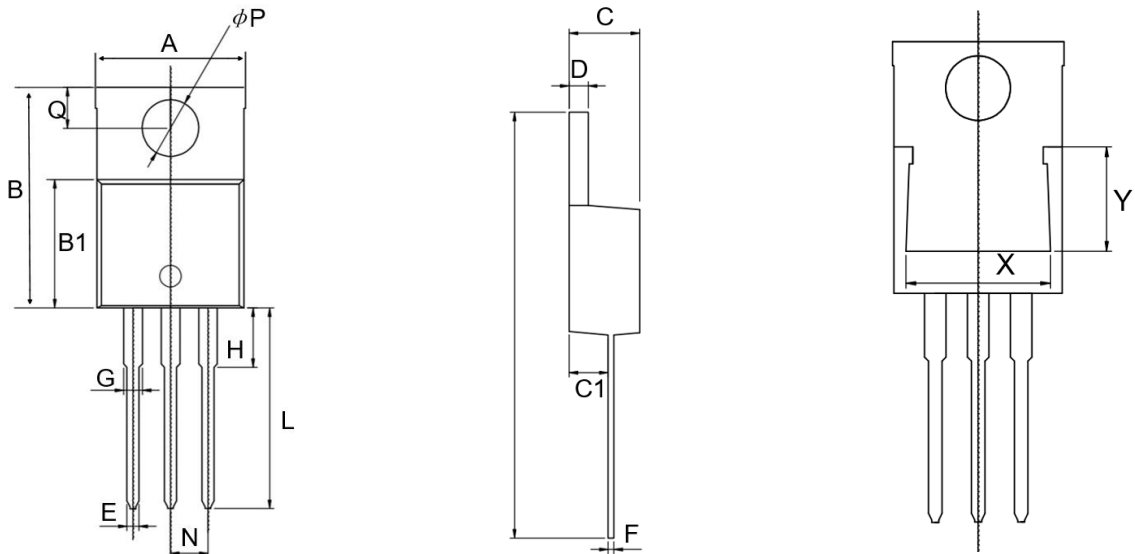
TO-220 Package

Items	Values (mm)		
	MIN	NOM	MAX
A	9.70	10.00	10.30
B	15.10	15.60	16.10
B1	8.80	9.10	9.40
C	4.37	4.57	4.70
C1	2.20	2.40	2.60
D	1.25	1.30	1.40
E	0.70	0.80	0.95
F	0.45	0.50	0.60
G	1.17	1.27	1.47
H	-	3.10	3.40
L	12.75	13.50	13.80
N	2.54		
Q	2.60	2.80	3.00
ΦP	3.40	3.60	3.80
X	7.00	-	-
Y	5.50	-	-

Revision History:

BLG3040 Revision: 2022-03-31, Rev. 2.0-I

Previous Revision

Revision	Date	Revision Date Subjects (major changes since last revision)
1.0	2019-10-21	-
1.1	2021-07-06	Some key Information has been added below. (1) Switching characteristics (2) Self-clamped Inductive switching current curves (3) Breakdown voltage curves have been added
2.0	2022-03-31	The major changes are as follow. (1) In Section 4, the data of ON characteristics and dynamic characteristics have been updated (2) In Section 5, P_D vs T_J curve and I_{SCIS} vs T_{CLP} curve have been added. (3) In Section 5, all figures of characteristics curves have been reformatted and adjusted in sequence. (4) In Section 6, all figures of test circuit and typical waveform have been redrawn and rearranged. (5) In Section 7, all diagrams of different package and some dimensions information have been redrawn and updated. (6) Formatting and spelling errors in this document have been corrected (7) Revision history is firstly added in the BLG3040 datasheet

We Listen to Your Comments

If there is any information within this document that you feel is wrong, unclear, or missing at all, please contact us.

Your feedback will help us to continuously improve the quality of this document.

Published by
Shanghai Belling Co., Ltd.
810, Yishan Road, Shanghai, China
© 2011 Belling
All Rights Reserved.

NOTE:

1. Any use beyond the maximum ratings of the device in performance may cause damage to the device or even the permanent failure, which may affect the dependability of the machine. Please do not exceed the absolute maximum ratings of the device when designing circuit.
2. When installing the heat sink, please pay attention to the torsional moment and the smoothness of the heat sink.
3. Semiconductor device is sensitive to the ESD, it is necessary to protect the device from being damaged by the ESD when using it.
4. Shanghai Belling reserves the right to make changes in this specification sheet and is subject to change without prior notice.

CONTACT:

上海贝岭股份有限公司 (总部)

地址: 上海市宜山路 810 号

邮编: 200233

电话: 021-24261000

产品业务咨询及技术支持

电话: 021-24261326

传真 2: 021-64852222

邮箱 2: marketing@belling.com.cn

上海贝岭深圳分公司 (华南区)

地址: 深圳市福田区中心区民田路新华保险大厦 1510 室

邮编: 518031

电话: 0755-33336776 0755-33336770

传真: 0755-33336788

上海贝岭北京办事处 (华北区)

地址: 北京市西城区新华里 16 号院锦官苑小区 10 号楼 1 单元 1505 室

邮编: 100044

电话: 010-64179374

传真: 010-8835 9236