

1. Description

BLG30T65FDL is obtained by advanced Trench Field Stop (T-FS) technology which is characteristic with low $V_{CE(sat)}$, optimized switching performance and low gate charge Q_g . The IGBT is suitable device for UPS, PFC, Photovoltaic Inverter and motor driver applications.

KEY CHARACTERISTICS

Parameter	Value	Unit
V_{CES}	650	V
I_c	30	A
$V_{CE(sat).typ}$	1.65	V

FEATURES

- Fast Switching
- Low $V_{CE(sat)}$
- Positive temperature coefficient
- Fast recovery anti-parallel diode
- RoHS product

APPLICATIONS

- UPS
- PFC
- Photovoltaic Inverter
- Motor driver

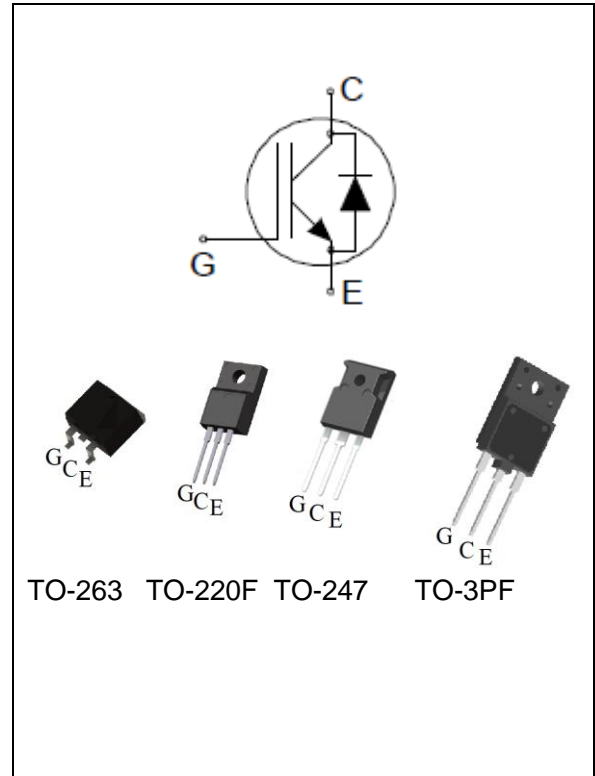

ORDERING INFORMATION

Device Marking	Ordering Codes	Package	Product Code	Packing
30T65FDL	BLG30T65FDL-A	TO-220F	BLG30T65FDL	Tube
	BLG30T65FDL-F	TO-247		Tube
	BLG30T65FDL-B	TO-263		Reel
	BLG30T65FDL-K	TO-3PF		Tube

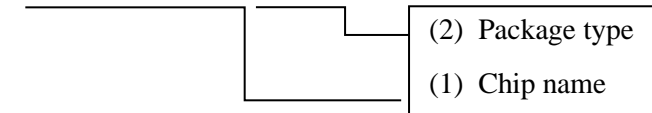
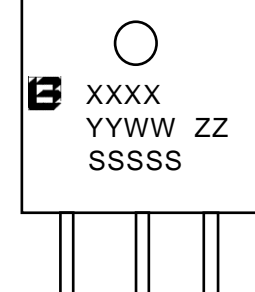
<p>BLG30T65FDL-A/F/B/W</p>  <p>(2) Package type (1) Chip name</p> <p>(1) BLG30T65FDL: 650V 30A (2) A:TO-220F F:TO-247 B:TO-263 K:TO-3PF</p>	 <p>XXXX: Product Code YYWW: Year & Week ZZ: Assembly Code SSSSS: Lot Code</p>
---	--

2. ABSOLUTE RATINGS

Symbol	Parameter	TO-247	TO-263	TO-3PF	TO-220F	Units
V_{CES}	Collector-Emitter Voltage	650				V
I_C	Collector Current @ $T_C=25^\circ\text{C}$	60				A
	Collector Current @ $T_C=100^\circ\text{C}$	30				A
I_{CM}	Pulsed Collector Current, tp limited by T_{Jmax}	90				A
I_F	Diode Continuous Forward Current @ $T_C=25^\circ\text{C}$	60				A
	Diode Continuous Forward Current @ $T_C=100^\circ\text{C}$	30				A
I_{FM}	Diode Maximum Forward Current, limited by T_{Jmax}	90				A
V_{GES}	Gate-Emitter Voltage	± 30				V
P_D	Power Dissipation @ $T_C=25^\circ\text{C}$	187	150	53	48	W
T_{Jmax}, T_{stg}	Operating Junction and Storage Temperature Range	175, -55 to 175				$^\circ\text{C}$
T_L	Maximum Temperature for Soldering	260				$^\circ\text{C}$

3. Thermal characteristics

Symbol	Parameter	TO-247	TO-263	TO-3PF	TO-220F	Units
$R_{\theta JC}$	Junction-to-Case (IGBT)	0.8	1.0	2.8	3.1	$^\circ\text{C}/\text{W}$
$R_{\theta JC}$	Junction-to-Case (Diode)	0.8	1.0	3.0	4.4	$^\circ\text{C}/\text{W}$
$R_{\theta JA}$	Junction-to-Ambient	40	40	40	78	$^\circ\text{C}/\text{W}$

4. Electrical Characteristics

at $T_C = 25^\circ\text{C}$, unless otherwise specified

Static Characteristics

Symbol	Parameter	Test Conditions	Values			Units
			Min.	Typ.	Max.	
V_{CES}	Collector-Emitter Breakdown Voltage	$V_{GE} = 0\text{V}, I_C = 250\mu\text{A}$	650	--	--	V
$V_{CE(sat)}$	Collector-Emitter Saturation Voltage	$V_{GE} = 15\text{V}, I_C = 30\text{A}$ $T_J = 25^\circ\text{C}$	--	1.65	2.05	V
		$T_J = 125^\circ\text{C}$	--	1.90	--	
		$T_J = 175^\circ\text{C}$	--	2.05	--	
$V_{GE(TH)}$	Gate Threshold Voltage	$V_{CE} = V_{GE}, I_C = 1\text{mA}$	4.7	5.5	6.2	V

V_F	Diode Forward Voltage	$I_F=30A$ $T_J=25^\circ C$ $T_J=125^\circ C$ $T_J=175^\circ C$	--	2.20	2.90	V
I_{CES}	Collector-Emitter Leakage Current	$V_{CE} = 650V,$ $V_{GE} = 0V$	--	--	35	μA
$I_{GES(F)}$	Gate-Emitter Forward Leakage Current	$V_{GE} = +30V$	--	--	200	nA
$I_{GES(R)}$	Gate-Emitter Reverse Leakage Current	$V_{GE} = -30V$	--	--	-200	nA
Pulse width $t_p \leq 300\mu s, \delta \leq 2\%$						

Dynamic Characteristics

Symbol	Parameter	Test Conditions	Values			Units
			Min.	Typ.	Max.	
C_{iss}	Input Capacitance	$V_{GE}=0V$ $V_{CE}=25V$ $f=1.0MHz$	--	1446	--	pF
C_{oss}	Output Capacitance		--	64	--	
C_{rss}	Reverse Transfer Capacitance		--	15	--	
Q_G	Gate charge	$V_{CC}=520V$ $I_{CE}=30A$ $V_{GE}=15V$	--	66	--	nC
Q_{GC}	Gate-emitter charge		--	27	--	
Q_{GE}	Gate-collector charge		--	18	--	
$I_{c(sc)}$	Short circuit collector current Max.1000 short circuits, Times between short circuits: $\geq 1.0s$	$V_{GE}=15.0V, V_{CC} \leq 400V$, $t_{sc} \leq 8\mu s, T_J \leq 175^\circ C$		120		A

IGBT Switching Characteristics, at $T_J=25^\circ C$

Symbol	Parameter	Test Conditions	Values			Units
			Min.	Typ.	Max.	
$t_{d(on)}$	Turn-on Delay Time	$I_C = 30A$ $V_{CE} = 400V$ $V_{GE} = 15V$ $R_G = 5\Omega$ $T_J = 25^\circ C$ Inductive Load	--	13	--	ns
t_r	Rise Time		--	9	--	
$t_{d(off)}$	Turn-Off Delay Time		--	68	--	
t_f	Fall Time		--	57	--	
E_{on}	Turn-On Switching Loss		--	0.53	--	mJ
E_{off}	Turn-Off Switching Loss		--	0.48	--	
E_{ts}	Total Switching Loss		--	1.01	--	

IGBT Switching Characteristics, at $T_J=175^\circ\text{C}$

Symbol	Parameter	Test Conditions	Values			Units
			Min.	Typ.	Max.	
$t_{d(on)}$	Turn-on Delay Time	$I_C = 30\text{A}$ $V_{CE} = 400\text{V}$ $V_{GE} = 15\text{V}$ $R_G = 5\Omega$ $T_J = 175^\circ\text{C}$ Inductive Load	--	12	--	ns
t_r	Rise Time		--	11	--	
$t_{d(off)}$	Turn-Off Delay Time		--	83	--	
t_f	Fall Time		--	96	--	
E_{on}	Turn-On Switching Loss		--	0.60	--	mJ
E_{off}	Turn-Off Switching Loss		--	0.70	--	
E_{ts}	Total Switching Loss		--	1.30	--	

Diode Characteristics, at $T_J=25^\circ\text{C}$

Symbol	Parameter	Test Conditions	Values			Units
			Min.	Typ.	Max.	
T_{rr}	Reverse Recovery Time	$I_F = 15\text{A}$, $di/dt = 200\text{A}/\mu\text{s}$, $T_J = 25^\circ\text{C}$	--	145	--	ns
Q_{rr}	Reverse Recovery Charge		--	326	--	nC
I_{rrm}	Reverse Recovery Current		--	4.2	--	A
T_{rr}	Reverse Recovery Time	$I_F = 30\text{A}$, $di/dt = 200\text{A}/\mu\text{s}$, $T_J = 25^\circ\text{C}$	--	158	--	ns
Q_{rr}	Reverse Recovery Charge		--	374	--	nC
I_{rrm}	Reverse Recovery Current		--	4.5	--	A

Diode Characteristics, at $T_J=175^\circ\text{C}$

Symbol	Parameter	Test Conditions	Values			Units
			Min.	Typ.	Max.	
T_{rr}	Reverse Recovery Time	$I_F = 15\text{A}$, $di/dt = 200\text{A}/\mu\text{s}$, $T_J = 175^\circ\text{C}$	--	193	--	ns
Q_{rr}	Reverse Recovery Charge		--	916	--	nC
I_{rrm}	Reverse Recovery Current		--	8.5	--	A
T_{rr}	Reverse Recovery Time	$I_F = 30\text{A}$, $di/dt = 200\text{A}/\mu\text{s}$, $T_J = 175^\circ\text{C}$	--	269	--	ns
Q_{rr}	Reverse Recovery Charge		--	1126	--	nC
I_{rrm}	Reverse Recovery Current		--	8.7	--	A

5. Characteristics Curves

Figure 1. Forward Bias Safe Operating Area for TO247

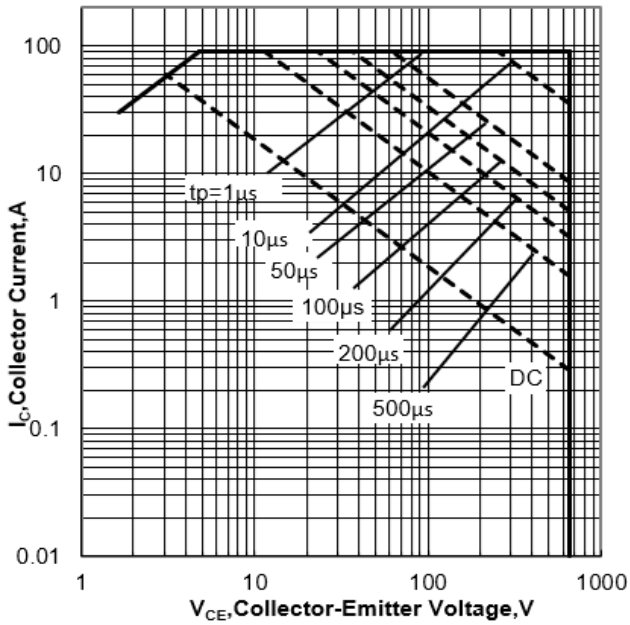

Figure 2. Forward Bias Safe Operating Area for TO220F

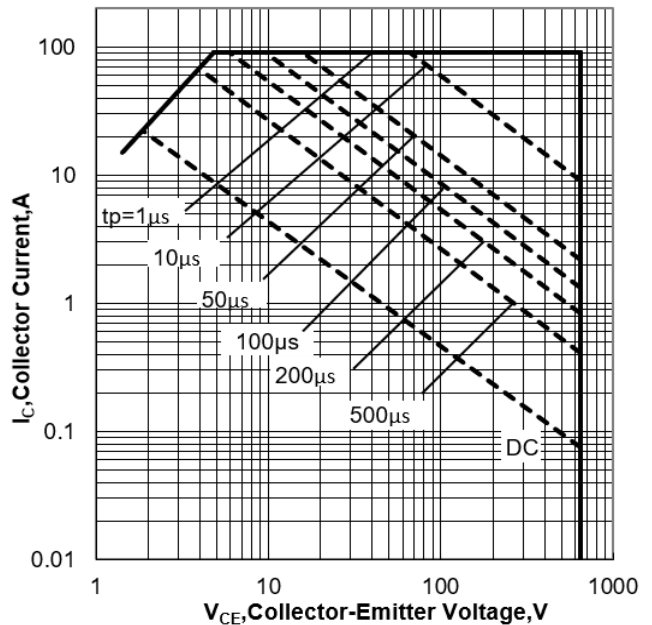

Figure 3. Forward Bias Safe Operating Area for TO3PF

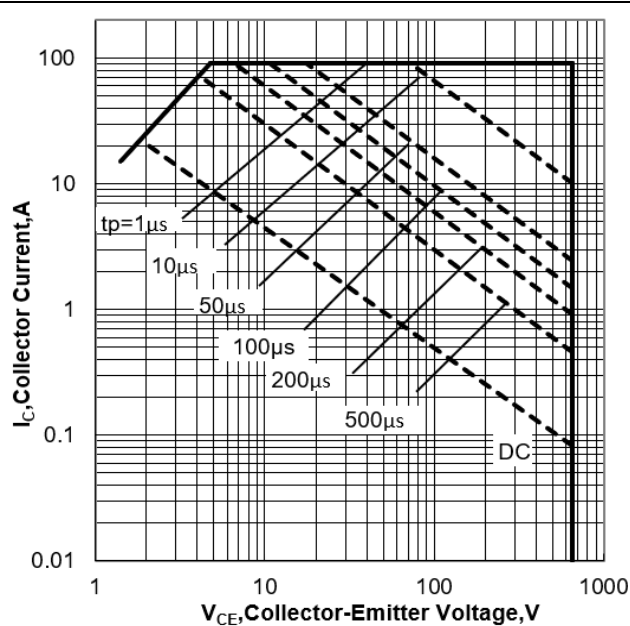

Figure 4. Forward Bias Safe Operating Area for TO263

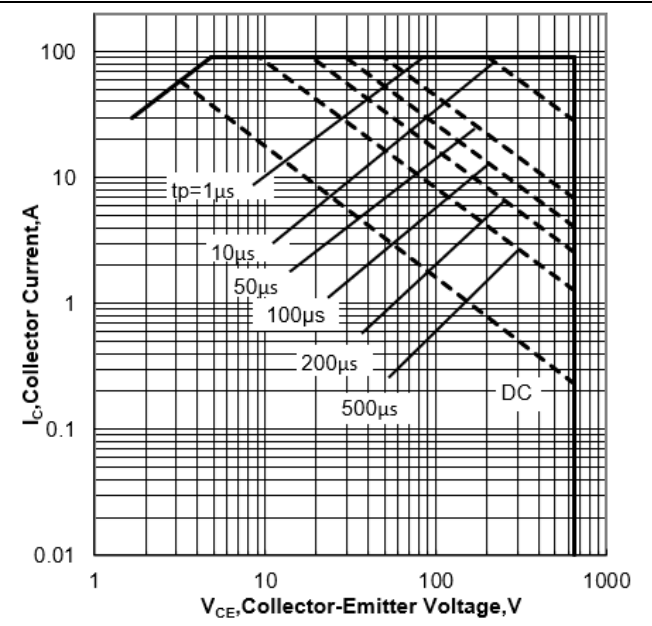

Figure 5. Power Dissipation vs Case Temperature for TO263

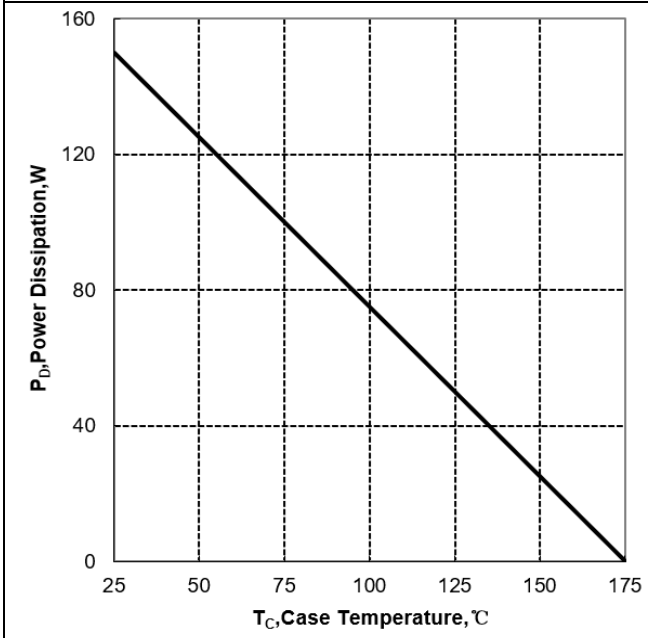

Figure 6. Power Dissipation vs Case Temperature for TO3PF

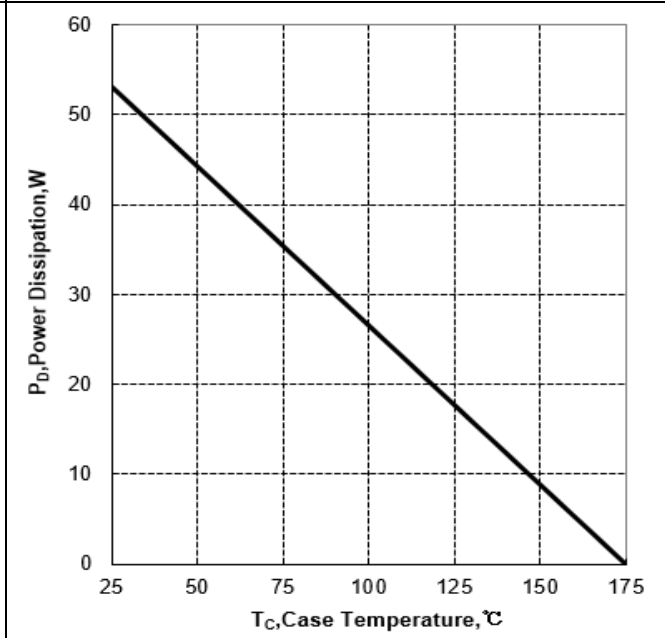

Figure 7. Power Dissipation vs Case Temperature for TO247

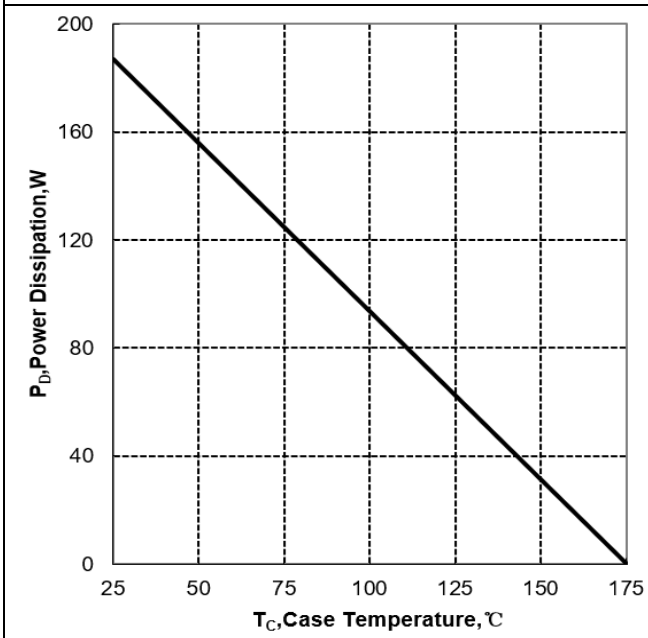

Figure 8. Power Dissipation vs Case Temperature for TO220F

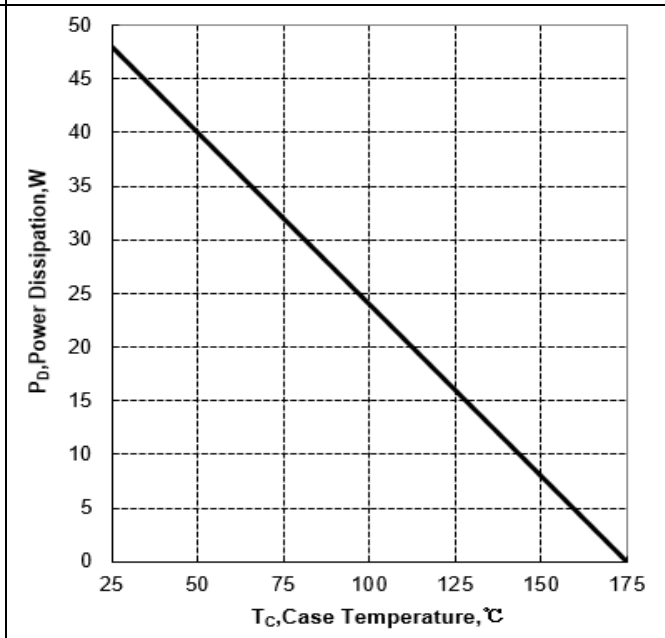

Figure 9. Collector Current vs Case Temperature

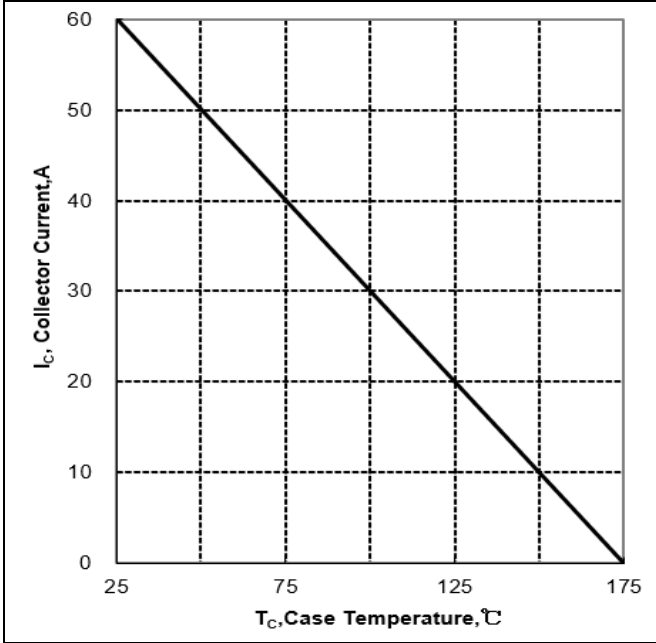

Figure 10. Typical Collector-Emitter Saturation Voltage vs Junction Temperature

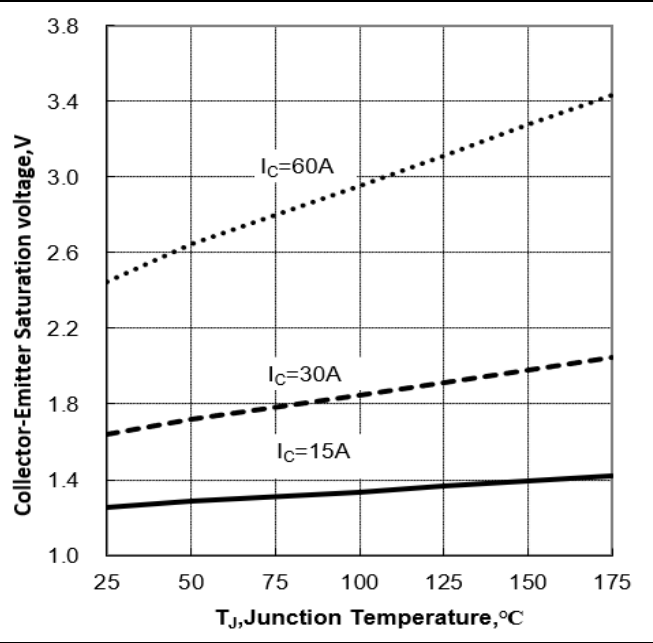

Figure 11. Typical Output Characteristics ($T_J=25^\circ\text{C}$)

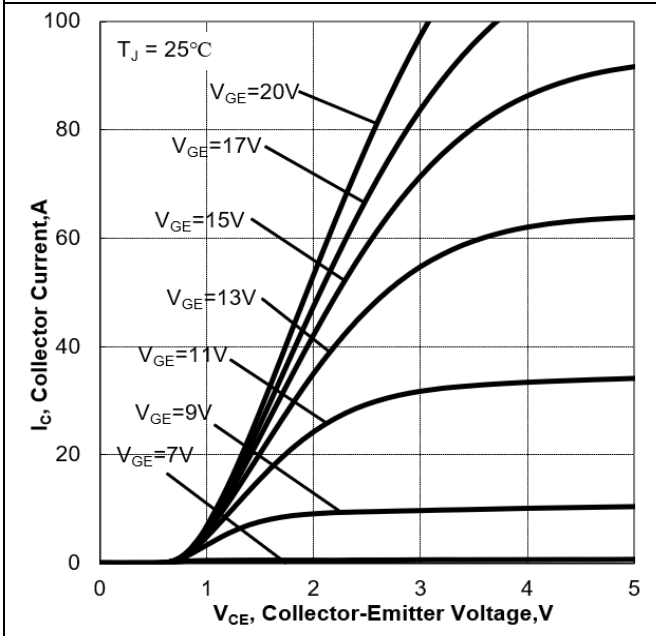

Figure 12. Typical Output Characteristics ($T_J=175^\circ\text{C}$)

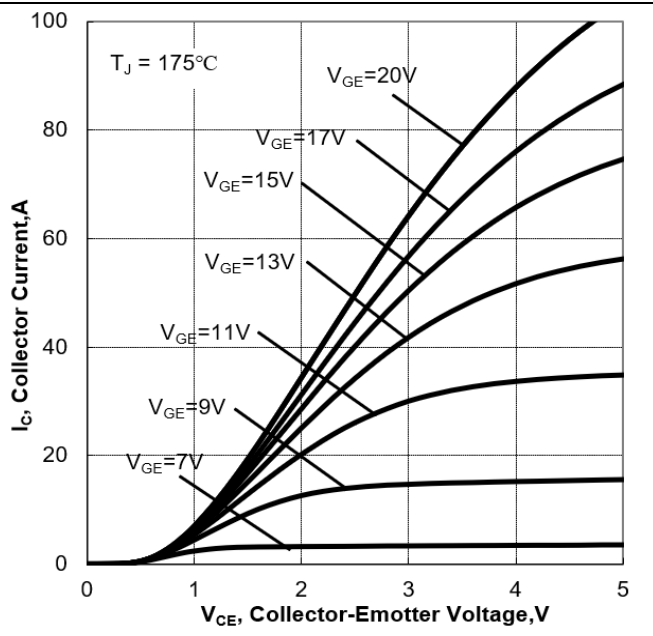

Figure 13. Typical Transfer Characteristics

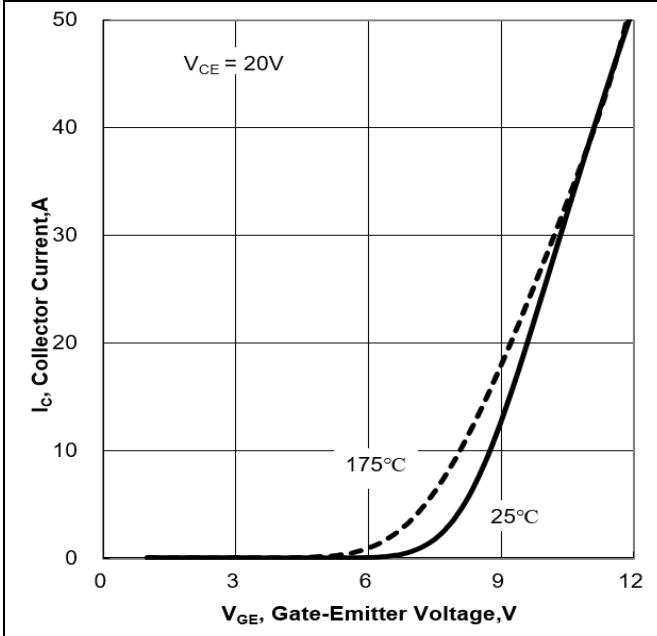

Figure 14. Typical Gate-Emitter Threshold Voltage vs Junction Temperature

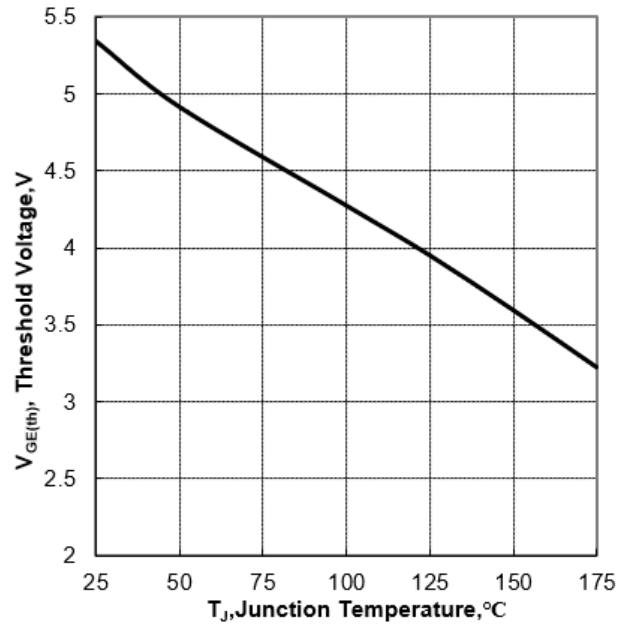

Figure 15. Typical Switching Times vs Gate Resistor ($T_J=25^\circ\text{C}$, $V_{CE}=400\text{V}$, $V_{GE}=15/0\text{V}$, $I_c=30\text{A}$)

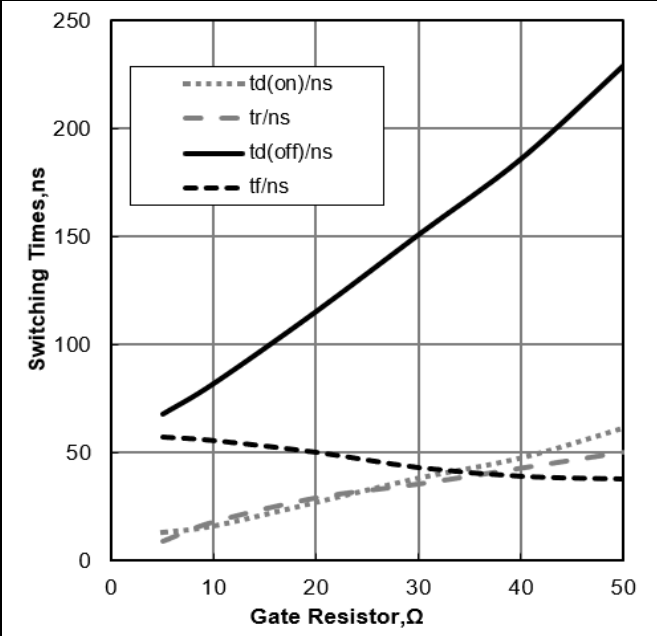
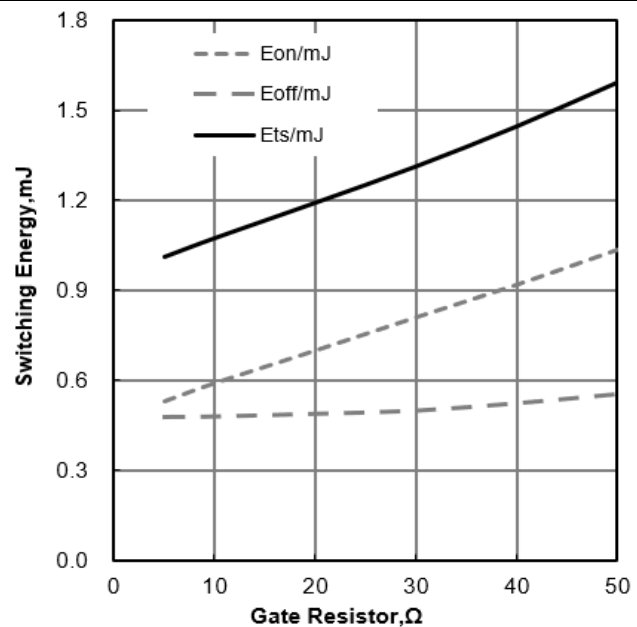

Figure 16. Typical Switching Energy vs Gate Resistor ($T_J=25^\circ\text{C}$, $V_{CE}=400\text{V}$, $V_{GE}=15/0\text{V}$, $I_c=30\text{A}$)



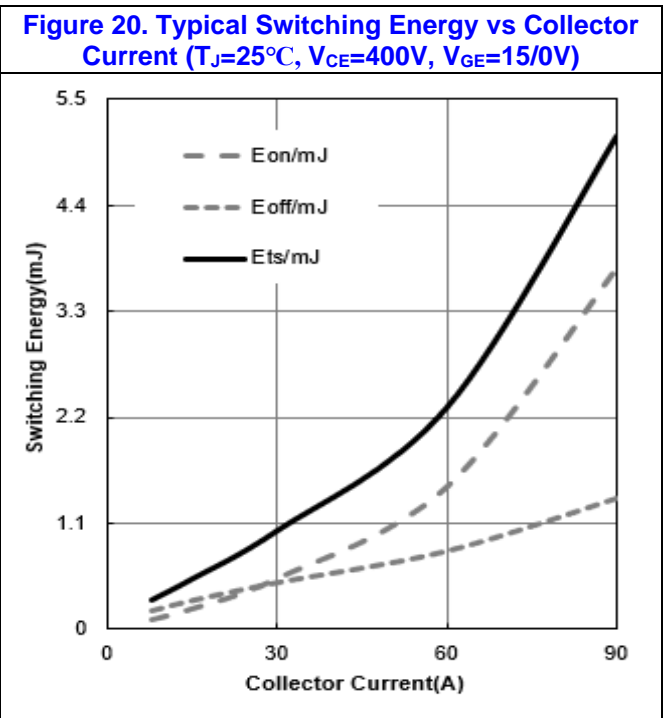
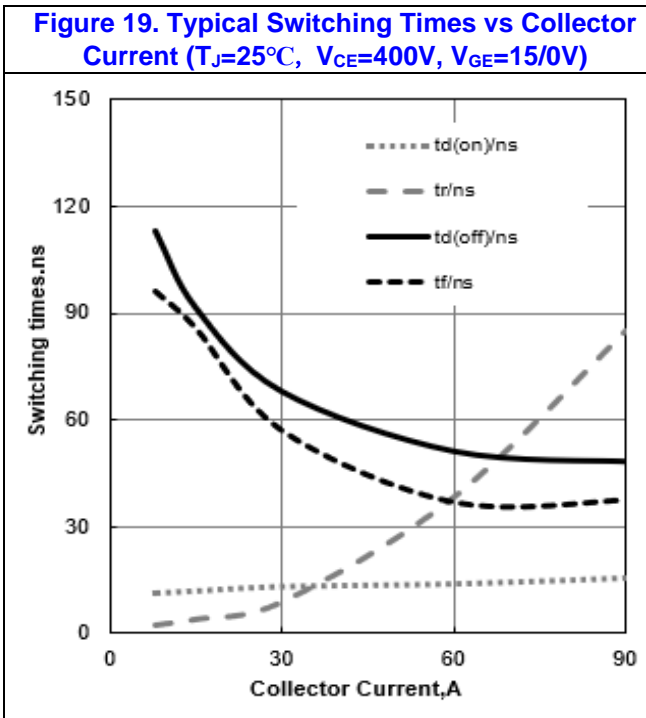
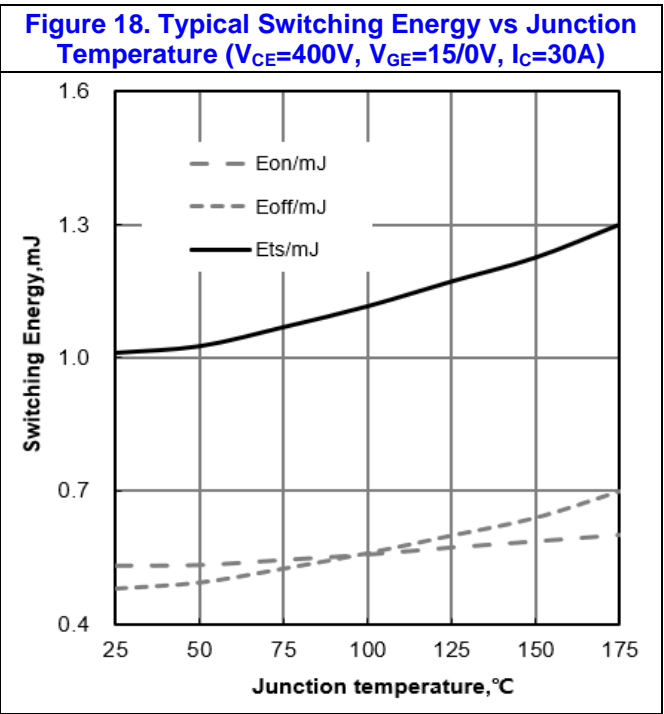
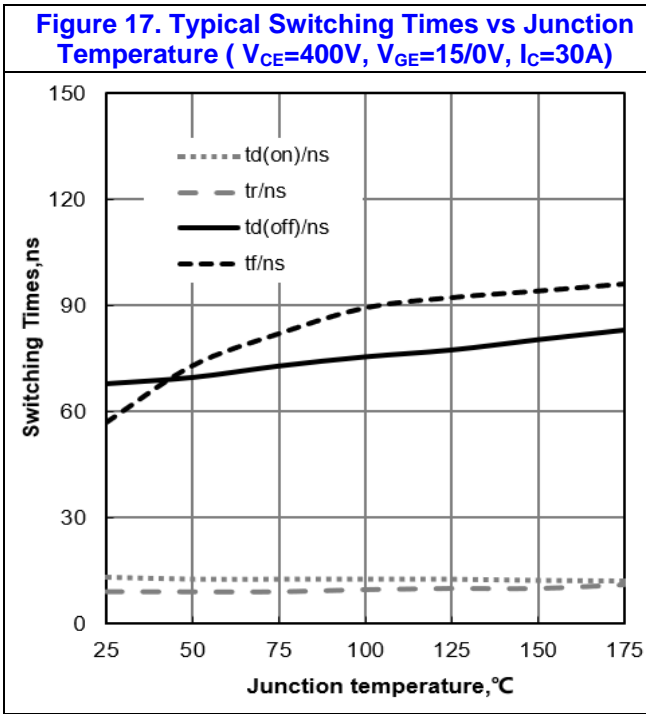

Figure 21. Typical Switching Times vs V_{CE}
($T_J=25^\circ\text{C}$, $V_{GE}=15/0\text{V}$, $I_C=30\text{A}$)

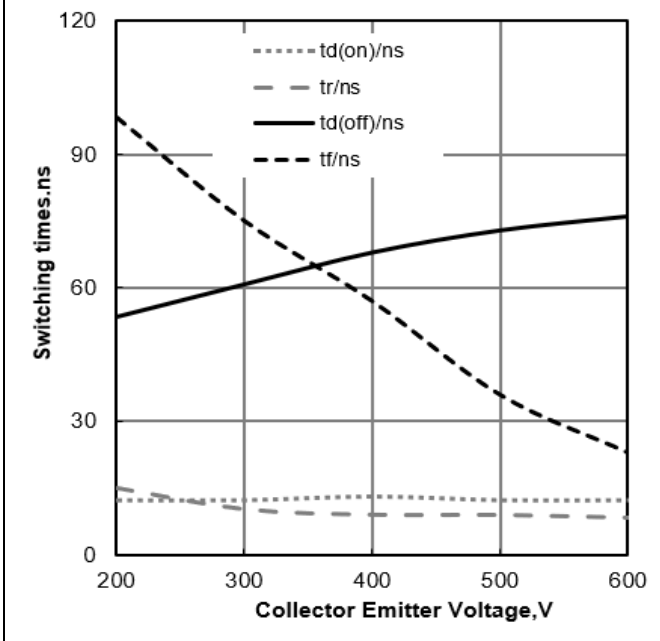

Figure 22. Typical Switching Energy vs V_{CE}
($T_J=25^\circ\text{C}$, $V_{GE}=15/0\text{V}$, $I_C=30\text{A}$)

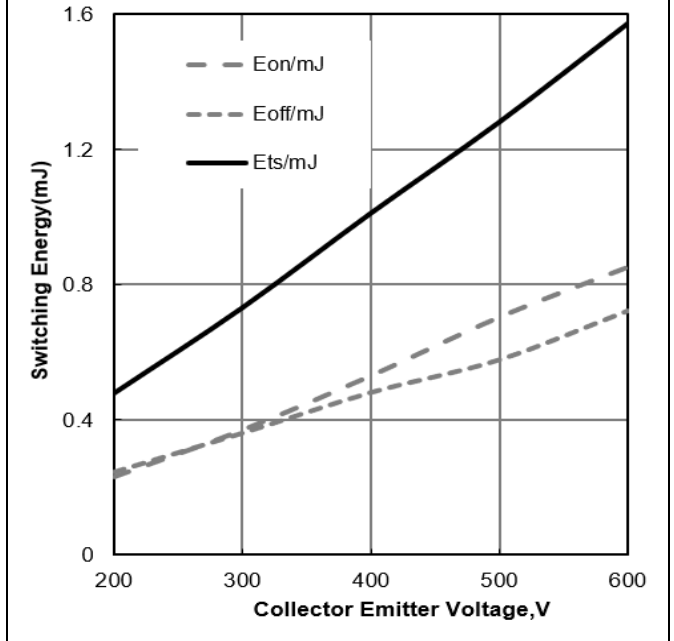

Figure 23. Typical Gate Charge

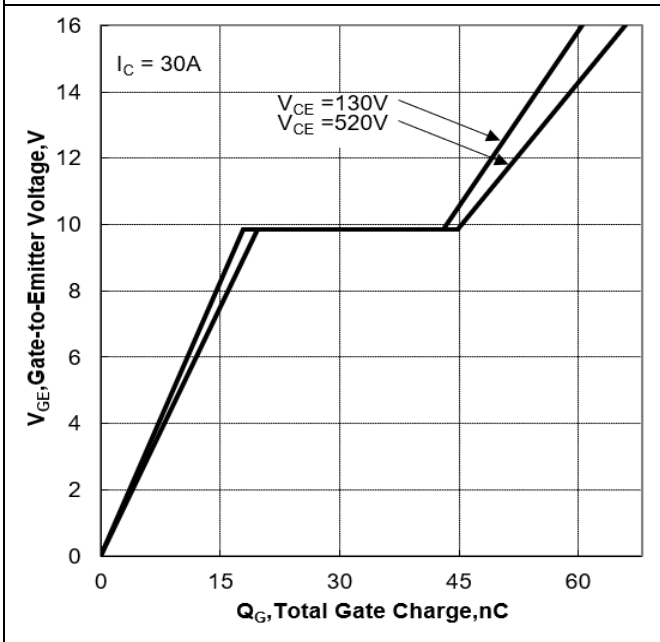

Figure 24. Typical Capacitance vs Collector-Emitter Voltage

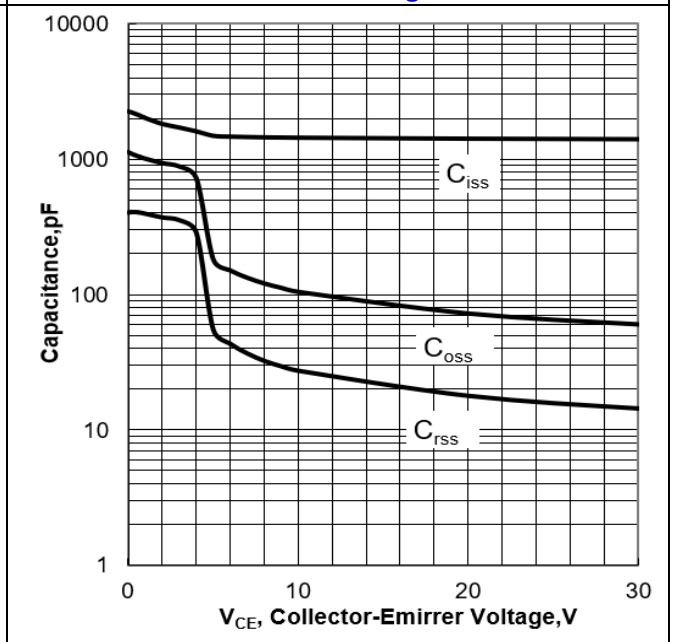

Figure 25. IGBT Transient Thermal Impedance vs Pulse Width(TO247)

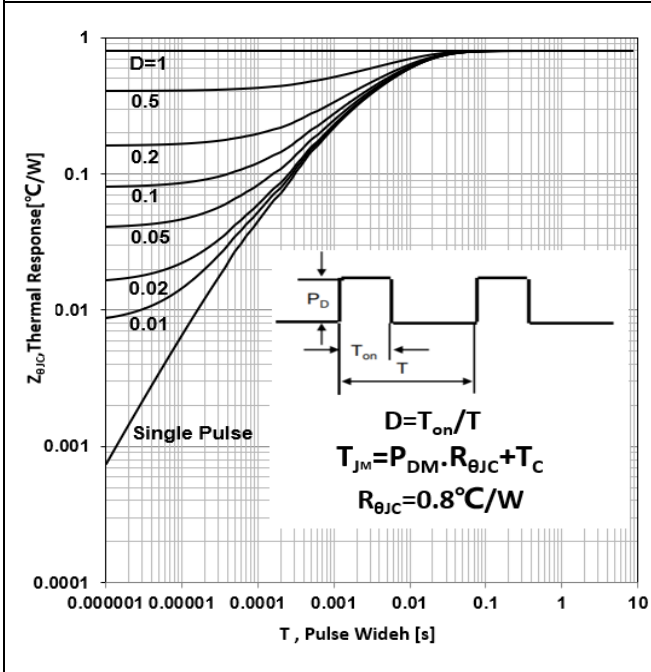

Figure 26. IGBT Transient Thermal Impedance vs Pulse Width(TO220F)

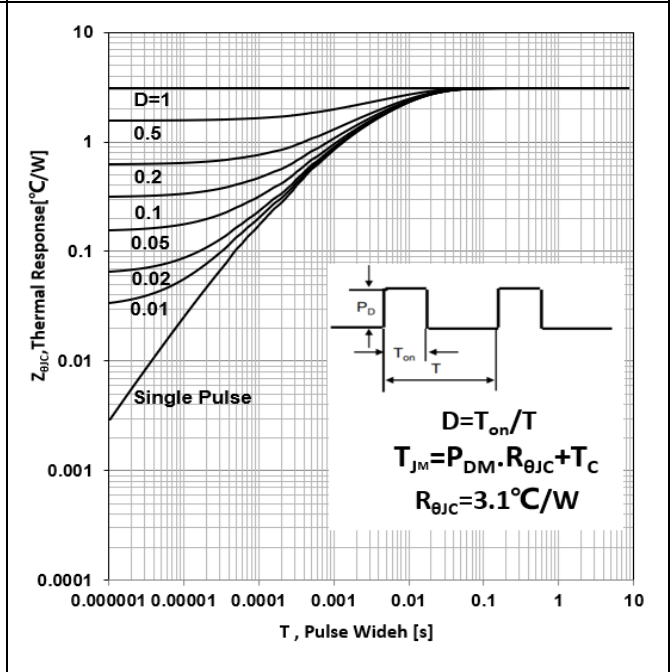

Figure 27. IGBT Transient Thermal Impedance vs Pulse Width(TO3PF)

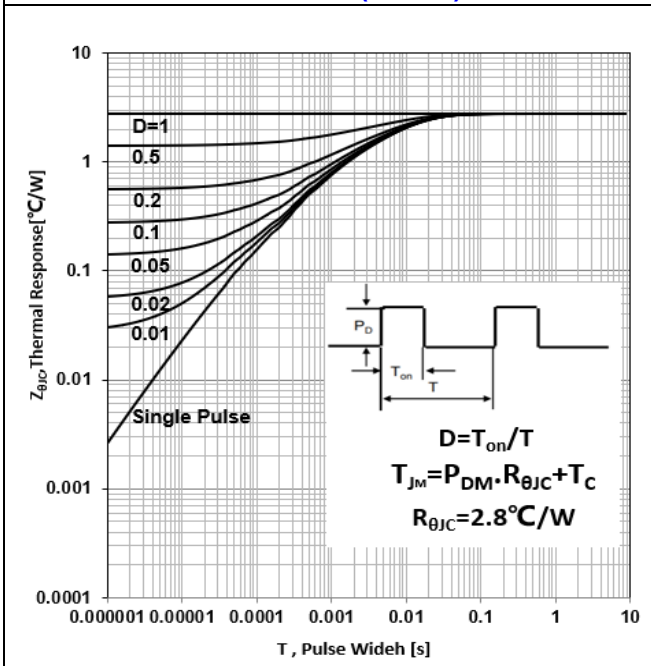

Figure 28. IGBT Transient Thermal Impedance vs Pulse Width(TO263)

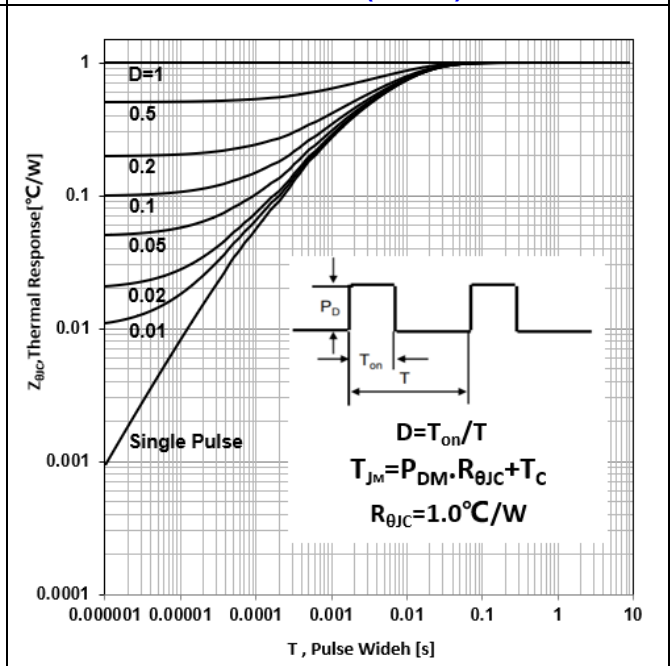

Figure 29. Diode Transient Thermal Impedance vs Pulse Width (TO263)

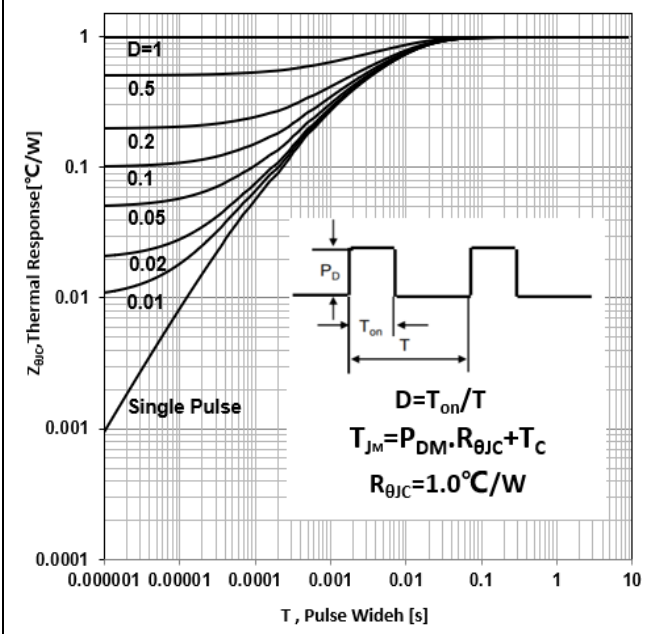

Figure 30. Diode Transient Thermal Impedance vs Pulse Width (TO3PF)

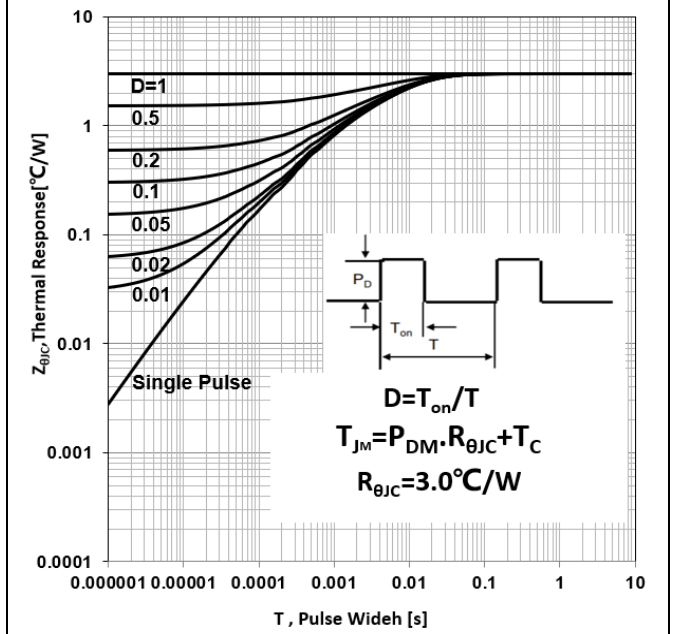

Figure 31. Diode Transient Thermal Impedance vs Pulse Width (TO247)

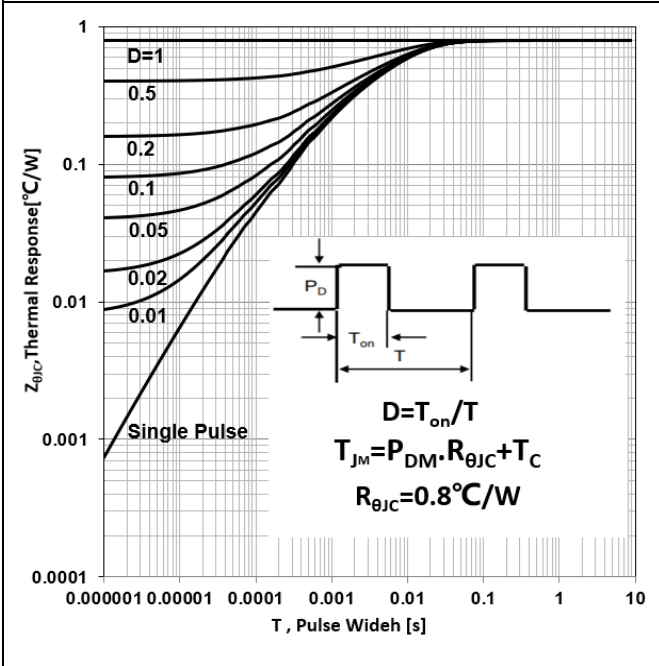

Figure 32. Diode Transient Thermal Impedance vs Pulse Width (TO220F)

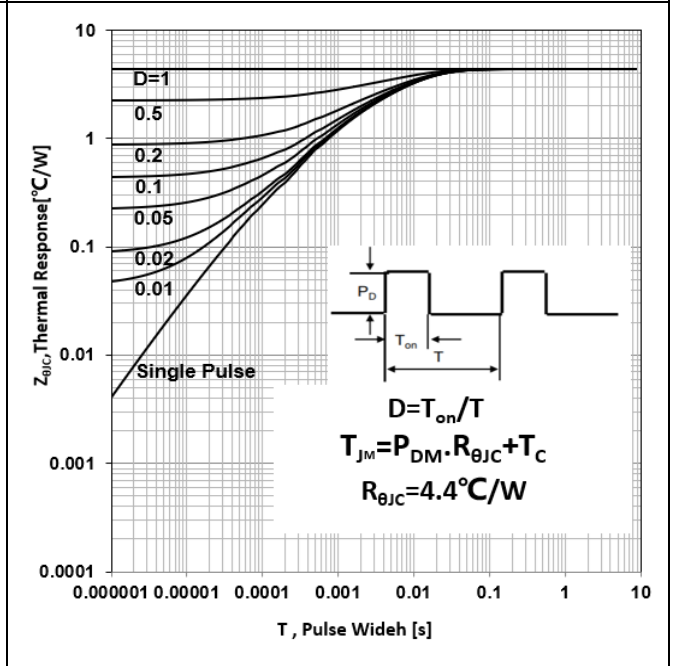
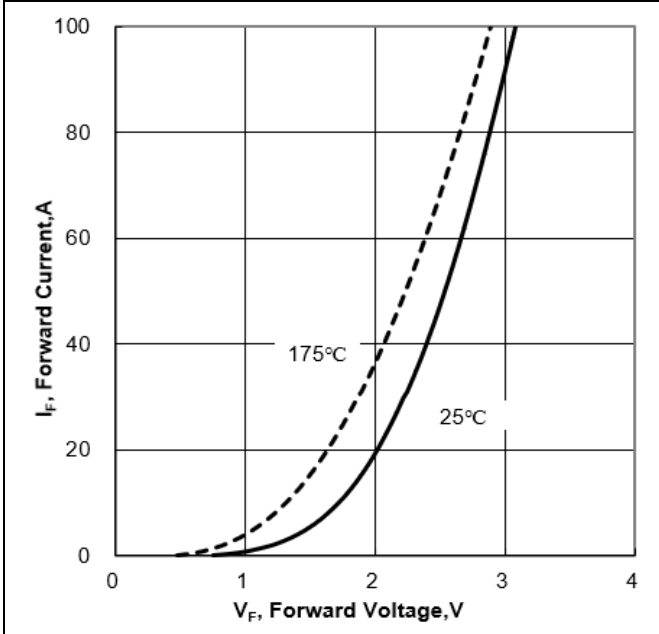
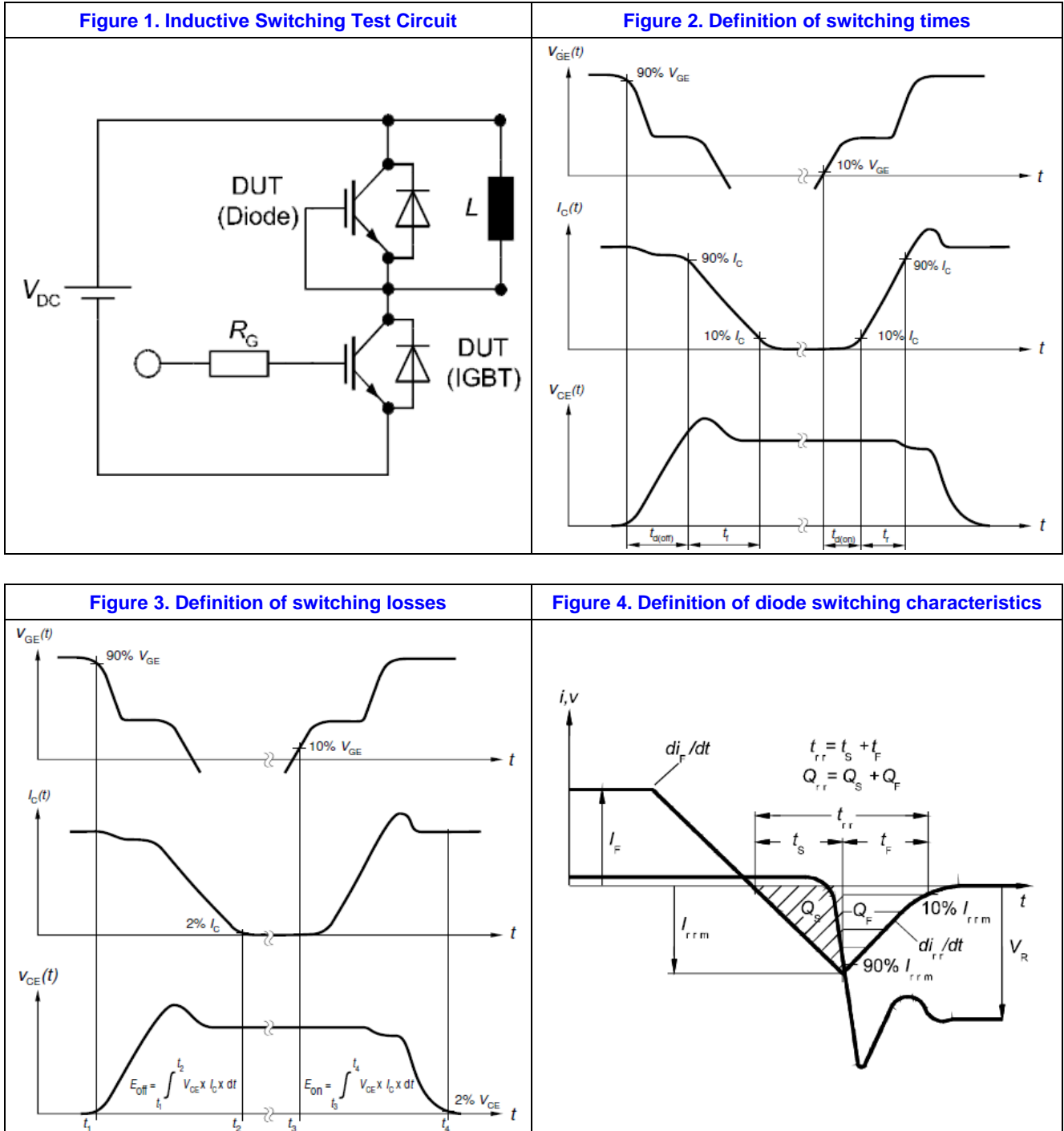

Figure 33. Typical Diode Forward Current vs Forward Voltage



6. Test Circuit and Waveform



7. Package Description

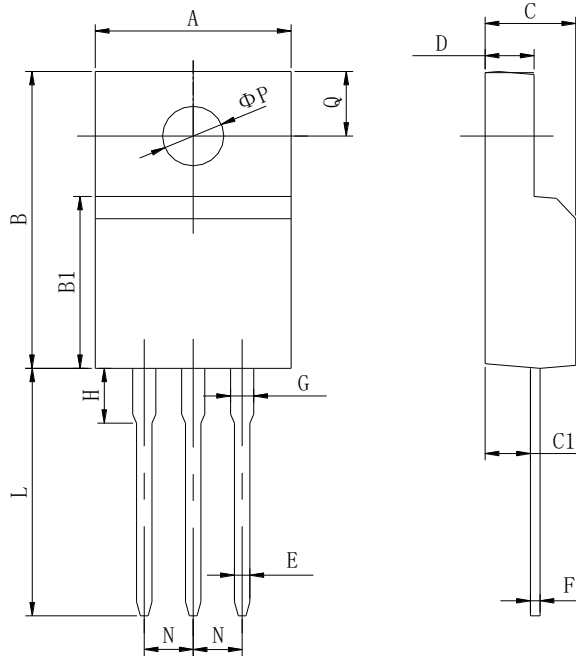

TO-220F Package

Items	Values(mm)	
	MIN	MAX
A	9.60	10.4
B	15.4	16.2
B1	8.90	9.50
C	4.30	4.90
C1	2.10	3.00
D	2.40	3.00
E	0.60	1.00
F	0.45	0.60
G	1.12	1.42
H	3.40	3.80
	1.60	2.90
L	12.0	14.0
N	2.34	2.74
Q	3.15	3.55
ϕP	2.90	3.30

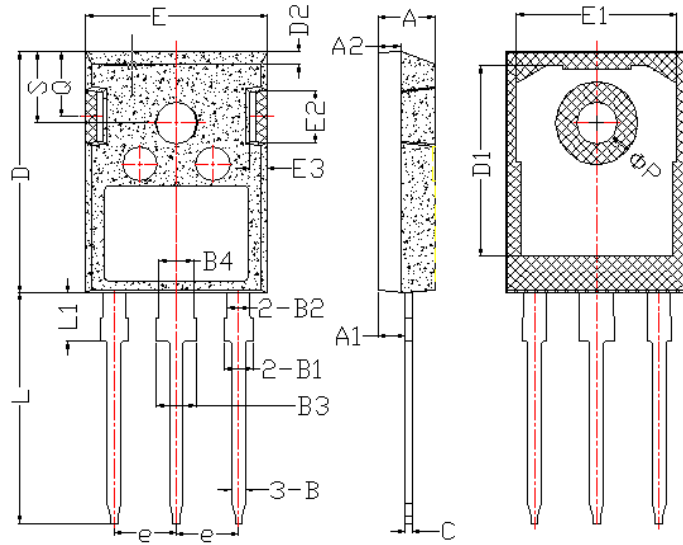

TO-247 Package

Items	Values(mm)	
	MIN	MAX
A	4.90	5.16
A1	2.27	2.53
A2	1.85	2.11
B	1.07	1.33
B1	1.90	2.41
B2	1.75	2.15
B3	2.87	3.38
B4	2.87	3.13
C	0.55	0.68
D	20.82	21.10
D1	16.25	17.65
D2	1.05	1.35
E	15.70	16.03
E1	13.10	14.15
E2	3.68	5.10
E3	1.68	2.60
e	5.44	
L	19.80	20.31
L1	4.17	4.47
ΦP	3.50	3.70
Q	5.49	6.00
S	6.04	6.30

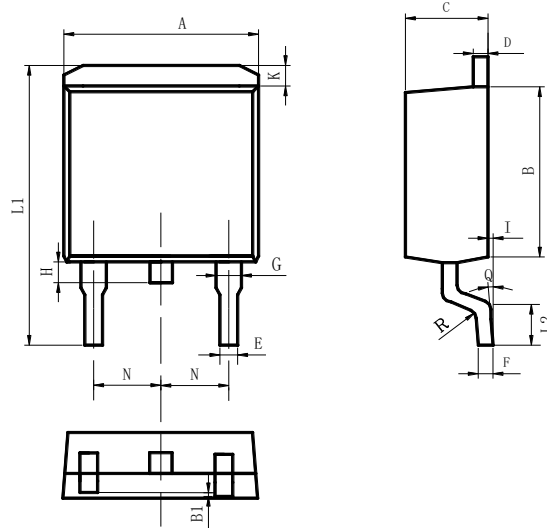

TO-263 Package

Items	Values(mm)	
	MIN	MAX
A	9.80	10.40
B	8.90	9.50
B1	0	0.10
C	4.40	4.80
D	1.16	1.37
E	0.70	0.95
F	0.30	0.60
G	1.07	1.47
H	1.30	1.80
K	0.95	1.37
L1	14.50	16.50
L2	1.60	2.30
I	0	0.2
Q	0°	8°
R	0.4	
N	2.39	2.69

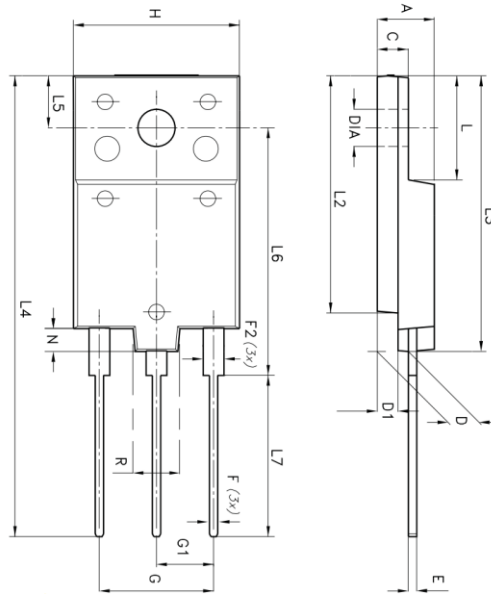

TO-3PF Package

Items	Values(mm)	
	MIN	MAX
A	5.30	5.70
C	2.80	3.20
D	3.10	3.50
D1	1.80	2.20
E	0.80	1.10
F	0.65	0.95
F2	1.80	2.20
G	10.30	11.50
G1	5.45	
H	15.30	15.70
L	9.80	10.20
L2	22.80	23.20
L3	26.30	26.70
L4	43.20	44.40
L5	4.3	4.70
L6	24.3	24.70
L7	14.6	15
N	1.8	2.2
R	3.8	4.2
Dia	3.4	3.8

NOTE:

1. Exceeding the maximum ratings of the device in performance may cause damage to the device, even the permanent failure, which may affect the dependability of the machine. Please do not exceed the absolute maximum ratings of the device when circuit designing.
2. When installing the heat sink, please pay attention to the torsional moment and the smoothness of the heat sink.
3. IGBTs is the device which is sensitive to the static electricity, it is necessary to protect the device from being damaged by the static electricity when using it.
4. Shanghai Belling reserves the right to make changes in this specification sheet and is subject to change without prior notice.

CONTACT:**上海贝岭股份有限公司**

地址：上海市宜山路 810 号

邮编：200233

联系方式：<https://www.belling.com.cn/contact.html>